

THERMOTEKNA

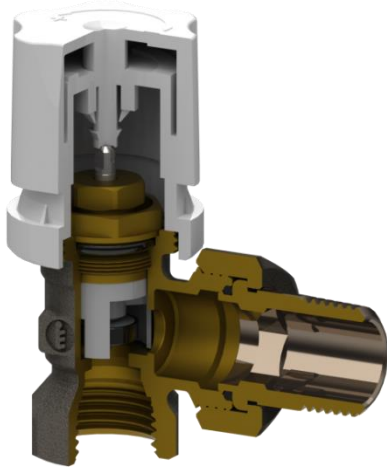

Function

ThermoTekna valves are suitable for any hot-water based heating system. Their function is to intercept the fluid and they allow to control the heating bodies. When used with thermostatic heads, these valves can make each room independent with a specific set temperature, thus enhancing comfort and actual energy saving, as prescribed by national and international regulations. Inside the valve body, the openings of a shaped acetal ring determine exactly the flow rate. The desired maximum flow rate can be set by simply rotating the stem to the corresponding position, without any intervention inside the valve. The thermostatic screw allows to replace one of the O-rings on the control stem without draining the system.

To avoid excessive noise in the system it is recommended not to use thermostatic valves with ΔP value above 0,2-0,25 bar.

Technical data

Max. working pressure:	10 bar
Max. differential pressure:	1 bar
Max. working temperature:	120 °C
Working fluids:	Water in compliance with UNI 8065:1989

Materials

Valve body:	CW 617 N – DW UNI-EN 12165:2016
Obturator:	CW 614 N – DW UNI-EN 12164:2016
Gaskets:	Peroxide cured EPDM
Adjustment knob	Acetal
Steek parts	Stainless steel
Knob:	RAL9016 white ABS

Surface treatment

Nickel-plating

Dimensional Drawings

RD 201

Straight radiator valve, thermostatically or electronically controlled with protection cap.
Connection for iron pipe.

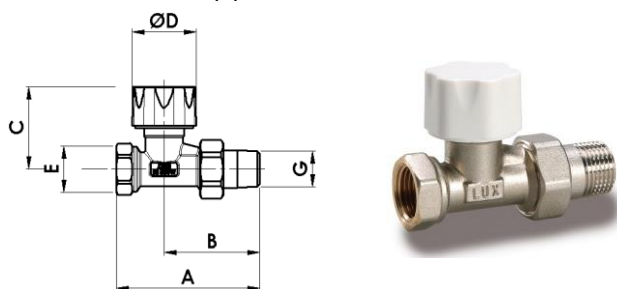

Code	Size	A	B	C	D	E
12221700	DN10 3/8	76	51	46	37	G3/8
12222100	DN15 1/2	83	55	46	37	G1/2
12222700	DN20 3/4	97	65	47	37	G3/4

Code	Size	F	G	H	L	M
12221700	DN10 3/8	-	R3/8	-	-	-
12222100	DN15 1/2	-	R1/2	-	-	-
12222700	DN20 3/4	-	R3/4	-	-	-

RS 202

Angle radiator valve, thermostatically or electronically controlled with protection cap.
Connection for iron pipe.

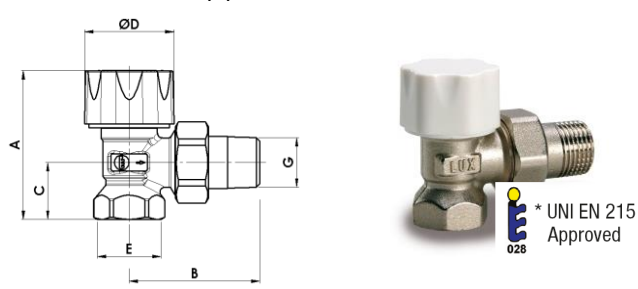

Code	Size	A	B	C	D	E
12021700	DN10 3/8	58	50	20	37	G3/8
12022100*	DN15 1/2	60	53	23	37	G1/2
12022700	DN20 3/4	60	62	27	37	G3/4

Code	Size	F	G	H	L	M
12021700	DN10 3/8	-	R3/8	-	-	-
12022100*	DN15 1/2	-	R1/2	-	-	-
12022700	DN20 3/4	-	R3/4	-	-	-

RD 2501

Straight radiator valve, thermostatically or electronically controlled, with manual control knob.
Connection for iron pipe.

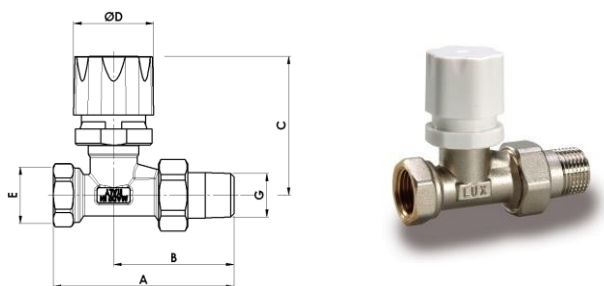

Code	Size	A	B	C	D	E
12421700	DN10 3/8	76	51	64	37	G3/8
12422100	DN15 1/2	83	55	64	37	G1/2
12422700	DN20 3/4	97	65	65	37	G3/4

Code	Size	F	G	H	L	M
12421700	DN10 3/8	-	-	G3/8	-	-
12422100	DN15 1/2	-	-	G1/2	-	-
12422700	DN20 3/4	-	-	G3/4	-	-

RS 2502

Angle radiator valve, thermostatically or electronically controlled, with manual control knob.
Connection for iron pipe.

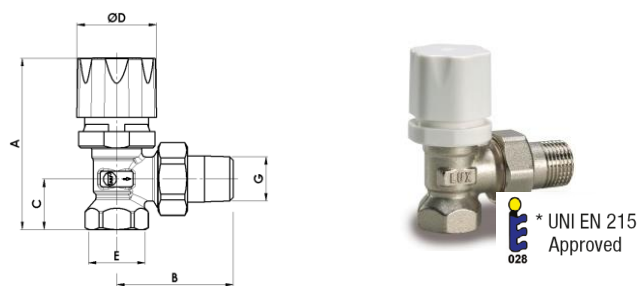

Code	Size	A	B	C	D	E
12621700	DN10 3/8	75	50	20	37	G3/8
12622100*	DN15 1/2	78	53	23	37	G1/2
12622700	DN20 3/4	78	62	27	37	G3/4

Code	Size	F	G	H	L	M
12621700	DN10 3/8	-	-	G3/8	-	-
12622100*	DN15 1/2	-	-	G1/2	-	-
12622700	DN20 3/4	-	-	G3/4	-	-

RD 205

Straight radiator valve, thermostatically or electronically controlled with protection cap. Unions with O-rings. Connection for iron pipe.

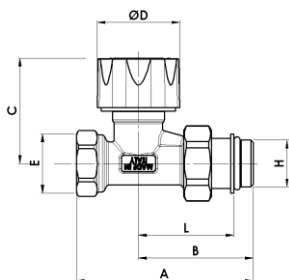

Code	Size	A	B	C	D	E
12222117	DN10 3/8	73	48	46	37	G3/8
12222103	DN15 1/2	78	51	46	37	G1/2
12222703	DN20 3/4	95	63	47	37	G3/4
Code	Size	F	G	H	L	M
12222117	DN10 3/8	-	-	G3/8	38	-
12222103	DN15 1/2	-	-	G1/2	40	-
12222703	DN20 3/4	-	-	G3/4	51	-

RS 206

Angle radiator valve, thermostatically or electronically controlled with protection cap. Unions with O-rings. Connection for iron pipe.

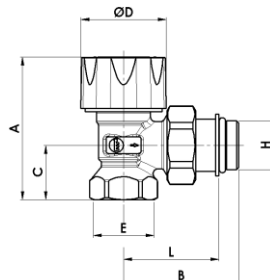

* UNI EN 215
Approved
028

Code	Size	A	B	C	D	E
12022117	DN10 3/8	58	47	20	37	G3/8
12022103*	DN15 1/2	61	49	23	37	G1/2
12022703	DN20 3/4	60	60	27	37	G3/4
Code	Size	F	G	H	L	M
12022117	DN10 3/8	-	-	G3/8	37	-
12022103*	DN15 1/2	-	-	G1/2	39	-
12022703	DN20 3/4	-	-	G3/4	48	-

RD 2505

Straight radiator valve, thermostatically or electronically controlled, with manual control knob. Unions with O-rings. Connection for iron pipe.

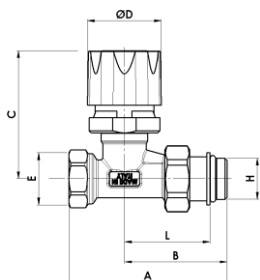

Code	Size	A	B	C	D	E
12422117	DN10 3/8	73	48	64	37	G3/4
12422103	DN15 1/2	78	51	64	37	G1/2
12422703	DN20 3/4	95	63	65	37	G3/4
Code	Size	F	G	H	L	M
12422117	DN10 3/8	-	-	G3/8	38	-
12422103	DN15 1/2	-	-	G1/2	40	-
12422703	DN20 3/4	-	-	G3/4	51	-

RS 2506

Angle radiator valve, thermostatically or electronically controlled, with manual control knob. Unions with O-rings. Connection for iron pipe.

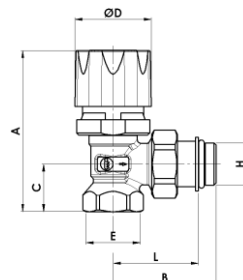

* UNI EN 215
Approved
028

Code	Size	A	B	C	D	E
12622117	DN10 3/8	75	47	20	37	G3/4
12622103*	DN15 1/2	78	49	23	37	G1/2
12622703	DN20 3/4	78	60	27	37	G3/4
Code	Size	F	G	H	L	M
12622117	DN10 3/8	-	-	G3/8	37	-
12622103*	DN15 1/2	-	-	G1/2	39	-
12622703	DN20 3/4	-	-	G3/4	48	-

RD 211

Straight radiator valve, thermostatically or electronically controlled with protection cap.
Copper and plastic pipe W24x19"

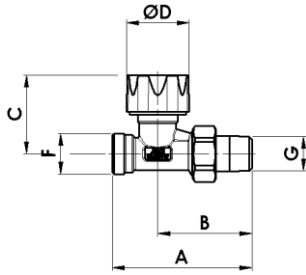

Code	Size	A	B	C	D	E
12321700	DN10 3/8	76	51	46	37	-
12322100	DN15 1/2	81	55	46	37	-

Code	Size	F	G	H	L	M
12321700	DN10 3/8 W24x19	R3/8	-	-	-	-
12322100	DN15 1/2 W24x19	R1/2	-	-	-	-

RS 212

Angle radiator valve, thermostatically or electronically controlled with protection cap.
Copper and plastic pipe W24x19"

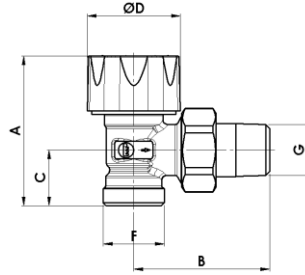

 * UNI EN 215 Approved

Code	Size	A	B	C	D	E
12121700*	DN10 3/8	57	52	19	37	-
12122100*	DN15 1/2	59	54	22	37	-

Code	Size	F	G	H	L	M
12121700*	DN10 3/8 W24x19	R3/8	-	-	-	-
12122100*	DN15 1/2 W24x19	R1/2	-	-	-	-

RD 2511

Straight radiator valve, thermostatically or electronically controlled, with manual control knob.
Copper and plastic pipe W24x19"

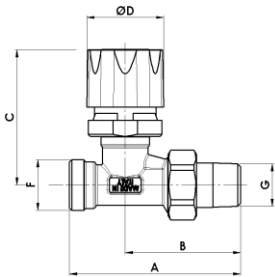

Code	Size	A	B	C	D	E
12521700	DN10 3/8	76	51	64	37	-
12522100	DN15 1/2	81	55	64	37	-

Code	Size	F	G	H	L	M
12521700	DN10 3/8 W24x19	R3/8	-	-	-	-
12522100	DN15 1/2 W24x19	R1/2	-	-	-	-

RS 2512

Angle radiator valve, thermostatically or electronically controlled, with manual control knob.
Copper and plastic pipe W24x19"

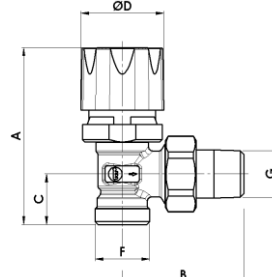

 * UNI EN 215 Approved

Code	Size	A	B	C	D	E
12721700*	DN10 3/8	74	52	19	37	-
12722100*	DN15 1/2	77	54	22	37	-

Code	Size	F	G	H	L	M
12721700*	DN10 3/8 W24x19	R3/8	-	-	-	-
12722100*	DN15 1/2 W24x19	R1/2	-	-	-	-

RD 208

Straight radiator valve, thermostatically or electronically controlled with protection cap. Unions with O-rings. Copper and plastic pipe W24x19"

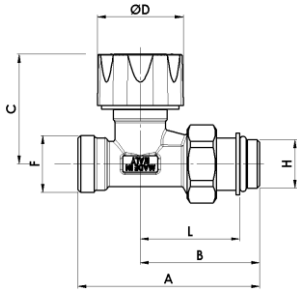

Code	Size	A	B	C	D	E
12322117	DN10 3/8	73	48	46	37	-
12322103	DN15 1/2	78	51	46	37	-
Code	Size	F	G	H	L	M
12322117	DN10 3/8 W24x19	-	G3/8	38	-	-
12322103	DN15 1/2 W24x19	-	G1/2	40	-	-

RS 209

Angle radiator valve, thermostatically or electronically controlled with protection cap. Unions with O-rings. Copper and plastic pipe W24x19"

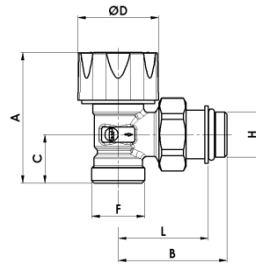

* UNI EN 215
028 Approved

Code	Size	A	B	C	D	E
12122117*	DN10 3/8	57	47	19	37	-
12122103*	DN15 1/2	60	49	22	37	-
Code	Size	F	G	H	L	M
12122117*	DN10 3/8 W24x19	-	G3/8	37	-	-
12122103*	DN15 1/2 W24x19	-	G1/2	39	-	-

RD 2508

Straight radiator valve, thermostatically or electronically controlled, with manual control knob. Unions with O-rings. Copper and plastic pipe W24x19"

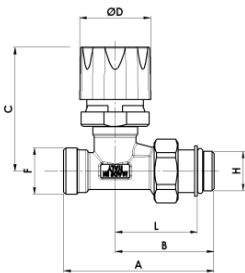

Code	Size	A	B	C	D	E
12522117	DN10 3/8	73	48	67	37	-
12522103	DN15 1/2	77	51	64	37	-
Code	Size	F	G	H	L	M
12522117	DN10 3/8 W24x19	-	G3/8	38	-	-
12522103	DN15 1/2 W24x19	-	G1/2	40	-	-

RS 2509

Angle radiator valve, thermostatically or electronically controlled, with manual control knob. Unions with O-rings. Copper and plastic pipe W24x19"

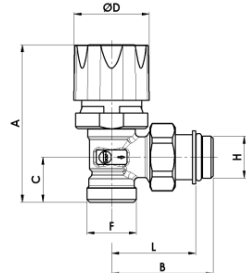

* UNI EN 215
028 Approved

Code	Size	A	B	C	D	E
12722117*	DN10 3/8	74	47	19	37	-
12722103*	DN15 1/2	77	49	22	37	-
Code	Size	F	G	H	L	M
12722117*	DN10 3/8 W24x19	-	G3/8	37	-	-
12722103*	DN15 1/2 W24x19	-	G1/2	39	-	-

RD 211/A

Straight radiator valve, thermostatically or electronically controlled with protection cap.
Copper and plastic pipe G3/4 Eurokonus

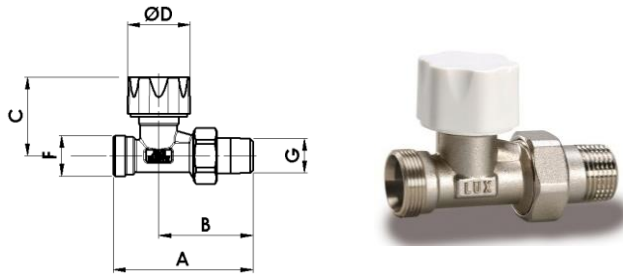

Code	Size	A	B	C	D	E
12322719	DN10 3/8	77	52	46	37	-
12322722	DN15 1/2	81	55	46	37	-

Code	Size	F	G	H	L	M
12322719	DN10 3/8	G3/4EK	R3/8	-	-	-
12322722	DN15 1/2	G3/4EK	R1/2	-	-	-

RS 212/A

Angle radiator valve, thermostatically or electronically controlled with protection cap.
Copper and plastic pipe G3/4 Eurokonus

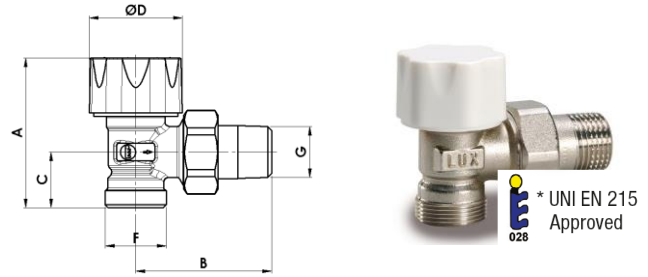

Code	Size	A	B	C	D	E
12122718*	DN10 3/8	56	50	19	37	-
12122721*	DN15 1/2	59	54	22	37	-

Code	Size	F	G	H	L	M
12122718*	DN10 3/8	G3/4EK	R3/8	-	-	-
12122721*	DN15 1/2	G3/4EK	R1/2	-	-	-

RD 2511/A

Straight radiator valve, thermostatically or electronically controlled, with manual control knob.
Copper and plastic pipe G3/4 Eurokonus

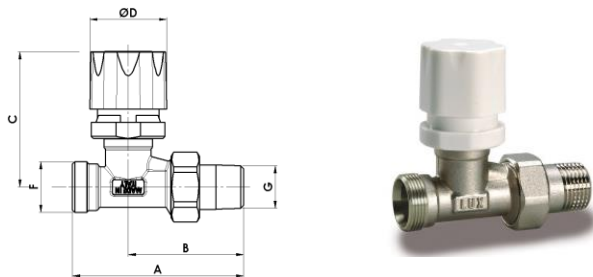

Code	Size	A	B	C	D	E
12522719	DN10 3/8	77	52	64	37	-
12522722	DN15 1/2	81	55	64	37	-

Code	Size	F	G	H	L	M
12522719	DN10 3/8	G3/4EK	R3/8	-	-	-
12522722	DN15 1/2	G3/4EK	R1/2	-	-	-

RS 2512/A

Angle radiator valve, thermostatically or electronically controlled, with manual control knob.
Copper and plastic pipe G3/4 Eurokonus



Code	Size	A	B	C	D	E
12722718*	DN10 3/8	74	52	19	37	-
12722721*	DN15 1/2	77	54	22	37	-

Code	Size	F	G	H	L	M
12722718*	DN10 3/8	G3/4EK	R3/8	-	-	-
12722721*	DN15 1/2	G3/4EK	R1/2	-	-	-

RD 208/A

Straight radiator valve, thermostatically or electronically controlled with protection cap. Unions with O-rings. Copper and plastic pipe G3/4 Eurokonus

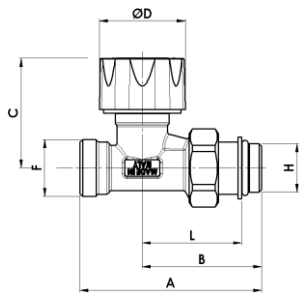

Code	Size	A	B	C	D	E
12322719	DN10 3/8	73	48	46	37	-
12322722	DN15 1/2	77	51	46	37	-
Code	Size	F	G	H	L	M
12322719	DN10 3/8	G3/4EK	-	G3/8	38	-
12322722	DN15 1/2	G3/4EK	-	G1/2	40	-

RS 209/A

Angle radiator valve, thermostatically or electronically controlled with protection cap. Unions with O-rings. Copper and plastic pipe G3/4 Eurokonus

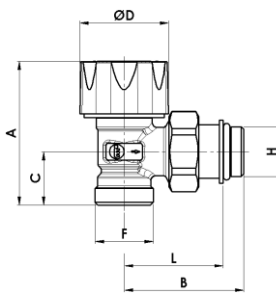

* UNI EN 215
028 Approved

Code	Size	A	B	C	D	E
12122718*	DN10 3/8	57	47	19	37	-
12122721*	DN15 1/2	60	49	22	37	-
Code	Size	F	G	H	L	M
12122718*	DN10 3/8	G3/4EK	-	G3/8	37	-
12122721*	DN15 1/2	G3/4EK	-	G1/2	39	-

RD 2508/A

Straight radiator valve, thermostatically or electronically controlled, with manual control knob. Unions with O-rings. Copper and plastic pipe G3/4 Eurokonus

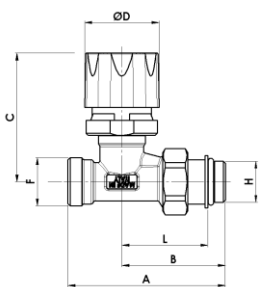

Code	Size	A	B	C	D	E
12522717	DN10 3/8	73	48	64	37	-
12522703	DN15 1/2	77	51	64	37	-
Code	Size	F	G	H	L	M
12522717	DN10 3/8	G3/4EK	-	G3/8	38	-
12522703	DN15 1/2	G3/4EK	-	G1/2	40	-

RS 2509/A

Angle radiator valve, thermostatically or electronically controlled, with manual control knob. Unions with O-rings. Copper and plastic pipe G3/4 Eurokonus

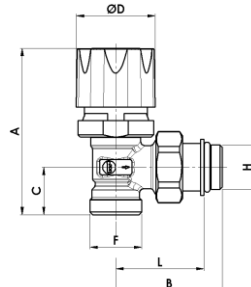

* UNI EN 215
028 Approved

Code	Size	A	B	C	D	E
12722717*	DN10 3/8	74	47	19	37	-
12722703*	DN15 1/2	77	49	22	37	-
Code	Size	F	G	H	L	M
12722717*	DN10 3/8	G3/4EK	-	G3/8	37	-
12722703*	DN15 1/2	G3/4EK	-	G1/2	39	-

M 320

Reverse angle radiator valve, thermostatically or electronically controlled, with protection cap.
Copper and plastic pipe W24x19"

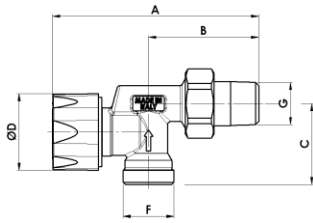

Code	Size	A	B	C	D	E
-	-	-	-	-	-	-
13102100	DN15 1/2	95	52	39	37	-
Code	Size	F	G	H	L	M
-	-	-	-	-	-	-
13102100	DN15 1/2	W24x19	R1/2	-	-	-

M 330

Reverse angle radiator valve, thermostatically or electronically controlled, with manual control knob.
Copper and plastic pipe W24x19"

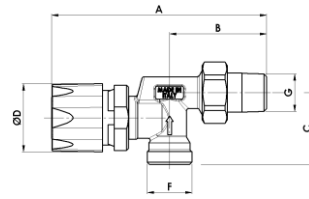

Code	Size	A	B	C	D	E
-	-	-	-	-	-	-
13122100	DN15 1/2	116	52	39	35	-
Code	Size	F	G	H	L	M
-	-	-	-	-	-	-
13122100	DN15 1/2	W24x19	R1/2	-	-	-

M 320/A

Reverse angle radiator valve, thermostatically or electronically controlled, with protection cap.
Copper and plastic pipe G3/4 Eurokonus

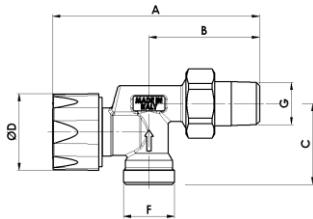

Code	Size	A	B	C	D	E
-	-	-	-	-	-	-
13102721	DN15 1/2	95	52	39	37	-
Code	Size	F	G	H	L	M
-	-	-	-	-	-	-
13102721	DN15 1/2	G3/4EK	R1/2	-	-	-

M 330/A

Reverse angle radiator valve, thermostatically or electronically controlled, with manual control knob.
Copper and plastic pipe G3/4 Eurokonus

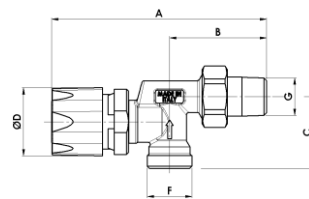

Code	Size	A	B	C	D	E
-	-	-	-	-	-	-
13122721	DN15 1/2	116	52	39	35	-
Code	Size	F	G	H	L	M
-	-	-	-	-	-	-
13122721	DN15 1/2	G3/4EK	R1/2	-	-	-

M 322

Reverse angle radiator valve, thermostatically or electronically controlled, with protection cap.
Connection for iron pipe.

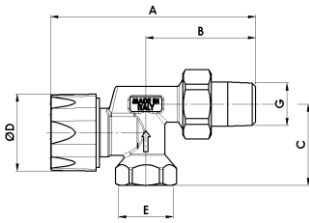

Code	Size	A	B	C	D	E
-	-	-	-	-	-	-
13202100	DN15 1/2	95	52	40	37	G1/2

Code	Size	F	G	H	L	M
-	-	-	-	-	-	-
13202100	DN15 1/2	-	R1/2	-	-	-

M 332

Reverse angle radiator valve, thermostatically or electronically controlled, with manual control knob.
Connection for iron pipe.

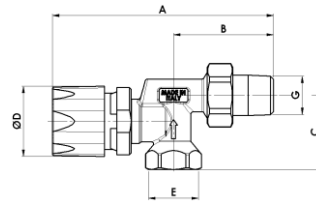

Code	Size	A	B	C	D	E
-	-	-	-	-	-	-
13222100	DN15 1/2	116	52	40	35	G1/2

Code	Size	F	G	H	L	M
-	-	-	-	-	-	-
13222100	DN15 1/2	-	R1/2	-	-	-

Hydraulic Characteristics

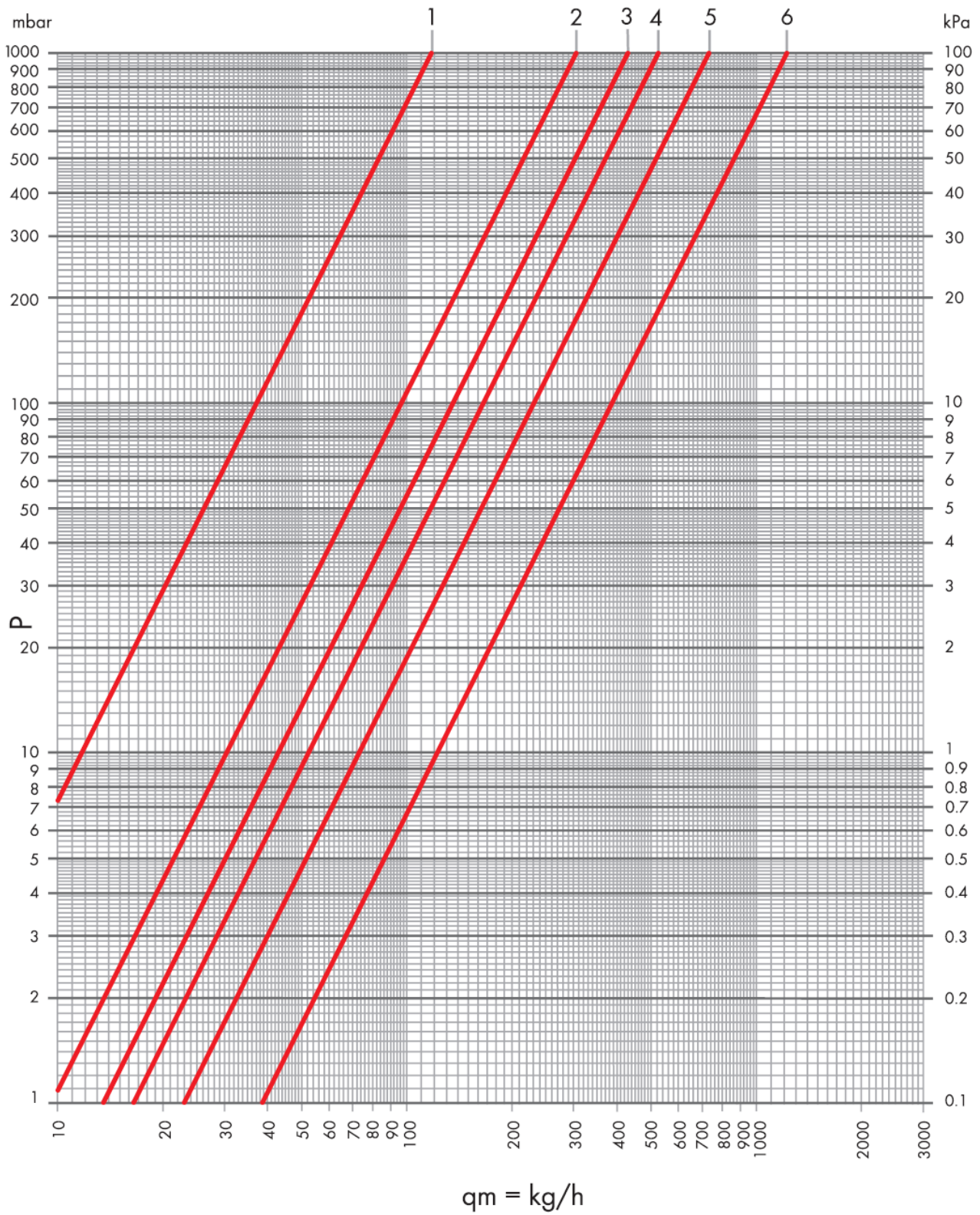

Curve	Kv	Kv Δt 1°C	Kv Δt 2°C	Items
1	0.12	0.10	0.11	DN10 and DN15 straight valves
2	0.30	0.20	0.25	
3	0.43	0.24	0.36	
4	0.52	0.24	0.37	
5	0.72	0.24	0.40	
6	1.21	0.29	0.49	

Hydraulic Characteristics

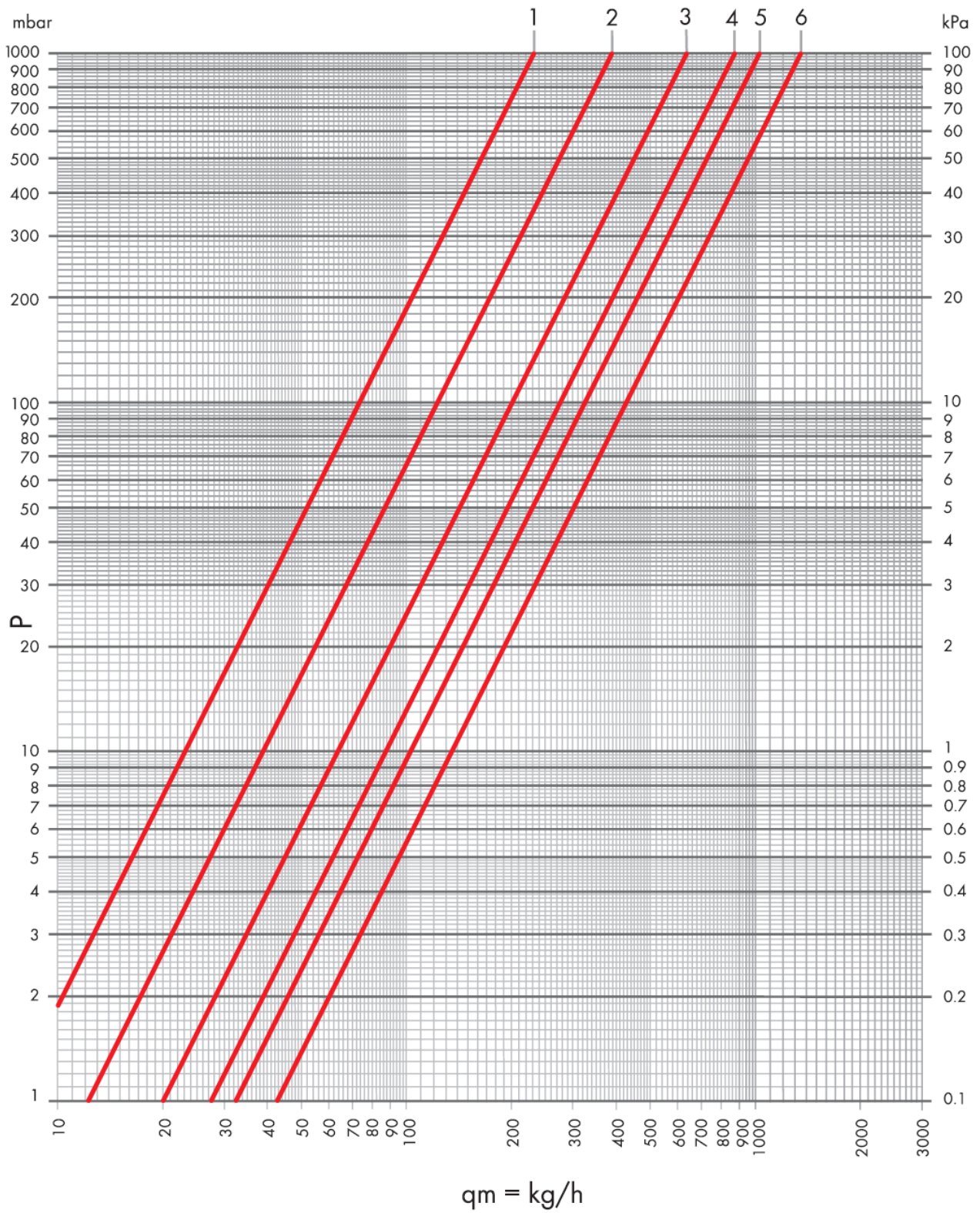

Curve	Kv	Kv Δt 1°C	Kv Δt 2°C	Items
1	0.23	0.16	0.19	DN20 straight valves
2	0.39	0.22	0.25	
3	0.63	0.25	0.36	
4	0.87	0.29	0.41	
5	1.02	0.30	0.50	
6	1.34	0.31	0.52	

Hydraulic Characteristics

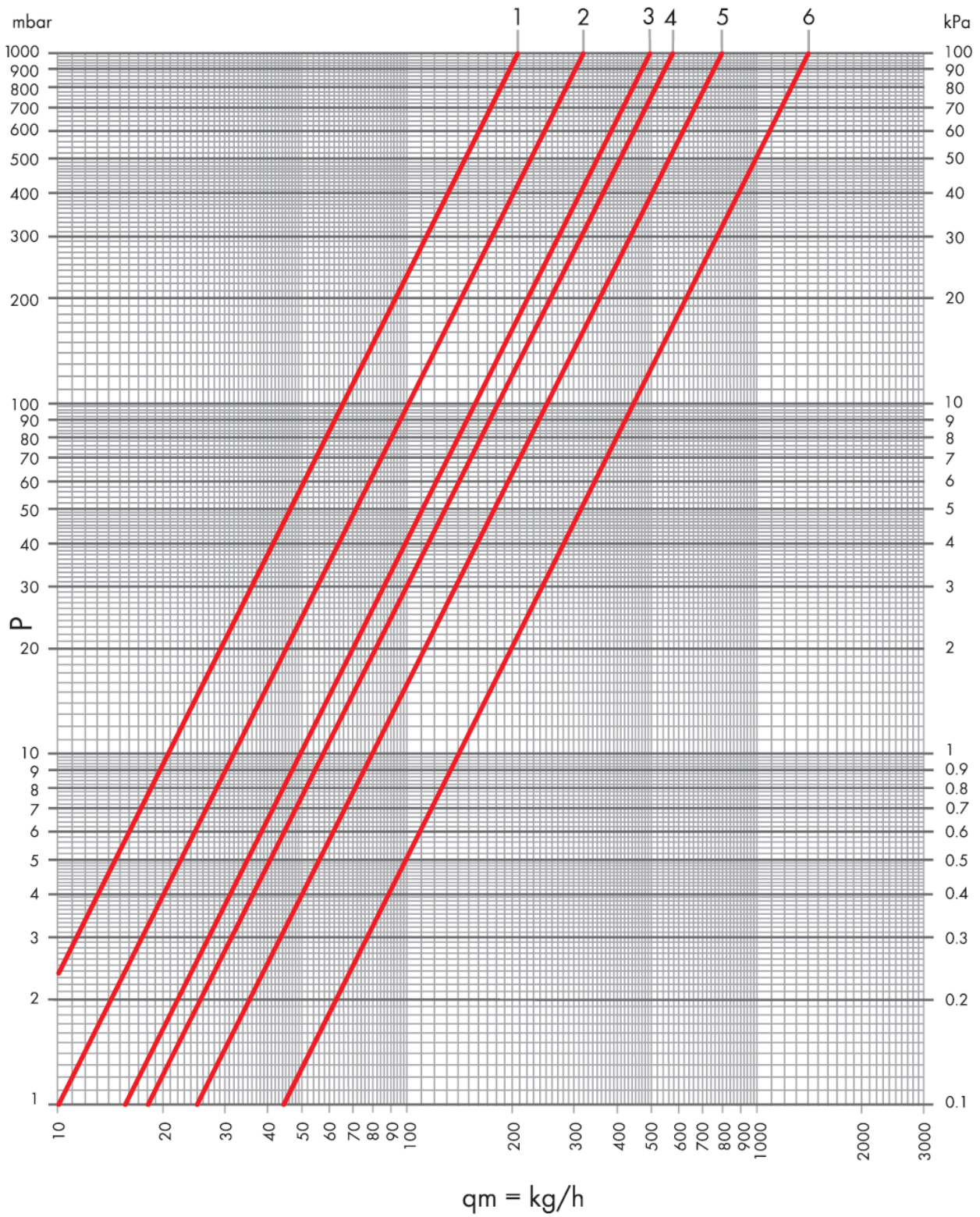

Curve	Kv	Kv Δt 1°C	Kv Δt 2°C	Items
1	0.21	0.15	0.19	DN10 and DN15 angle valves
2	0.32	0.22	0.25	
3	0.49	0.24	0.36	
4	0.57	0.24	0.37	
5	0.79	0.24	0.40	
6	1.39	0.32	0.55	

Hydraulic Characteristics

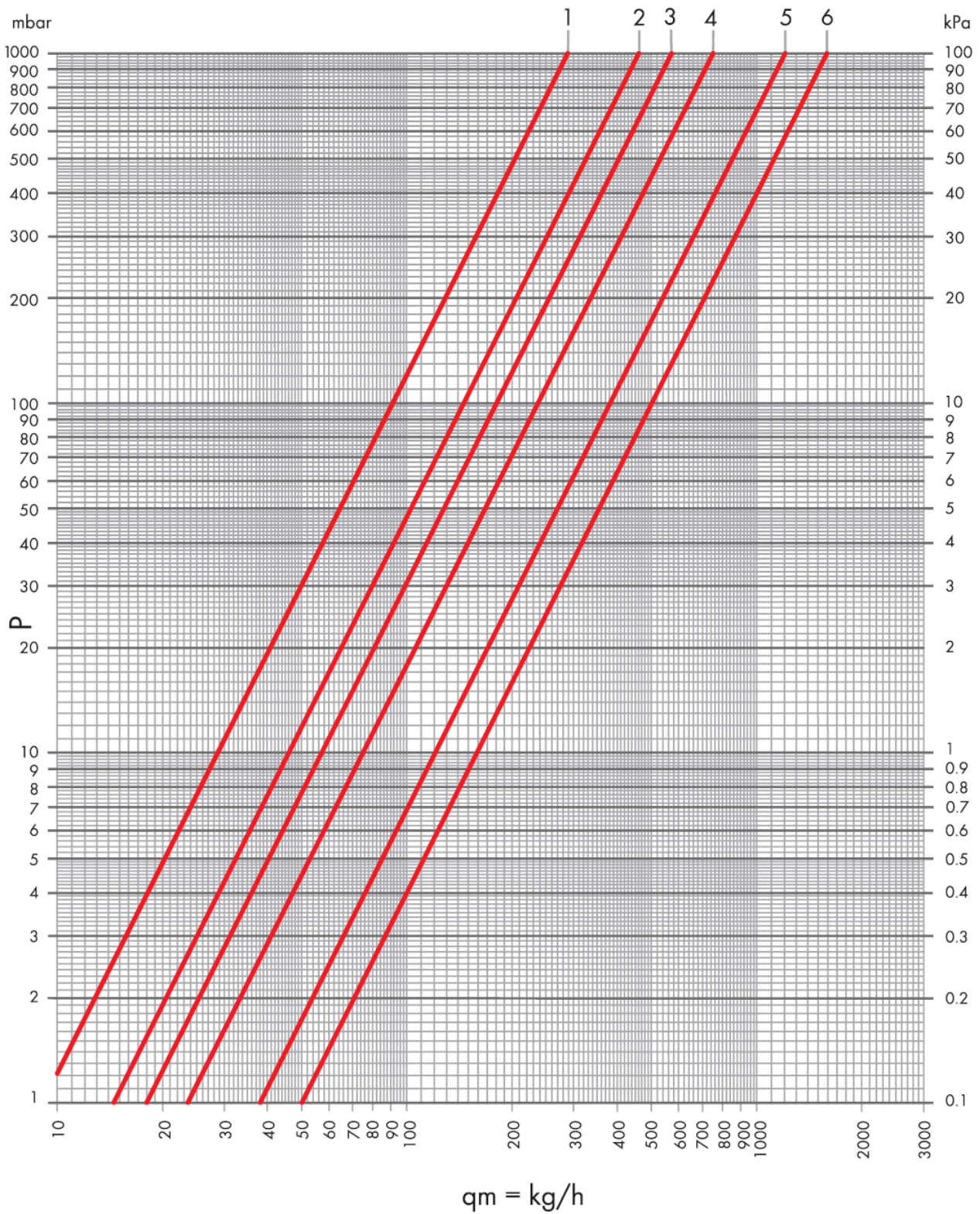

Curve	Kv	Kv Δt 1°C	Kv Δt 2°C	Items
1	0.29	0.15	0.19	DN20 angle valves
2	0.49	0.20	0.25	
3	0.57	0.24	0.36	
4	0.75	0.26	0.41	
5	1.20	0.31	0.55	
6	1.58	0.32	0.56	

Working Instructions

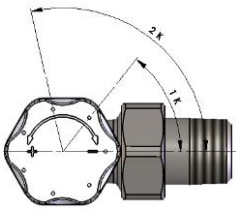

- **PROTECTION CAP:** Protects the thread during installation and allows for full closing of the valve. It enables to calibrate the nominal lift as follows:
 - Turn the cap until the valve is completely closed without forcing;
 - Draw a reference line on the valve body corresponding with one of the cap's notches;
 - Unplug the cap for two notches.



- **STEM SEALING:** The tightening device can be easily replaced without draining the system:
 - Unscrew the hexagonal collar by means of a 13 mm wrench;



- Remove the O-ring "A", clean the stainless steel stem and insert a new O-ring "A";
- Screw the collar tightly back.

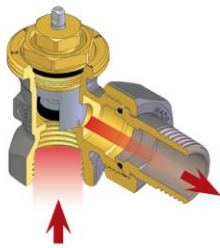
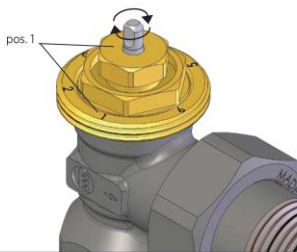

- **FLOW RATE ADJUSTMENT:** To set the maximum flow rate:
 - Align the reference mark "B" on the stainless steel stem with one of the positions printed on the valve body.

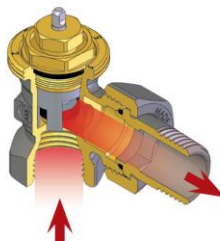
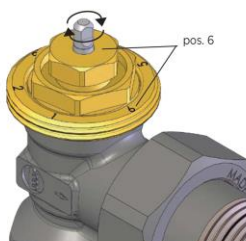

- **WARNING:** Once the system has been leak tested, please relieve the pressure. A differential pressure over 1 bar between the inlet and the outlet of the valve may cause the sealing O-ring to be expelled.

Item Specifications

RD 201

Straight radiator valve, thermostatically or electronically controlled with white ABS protection cap. ISO 228/1 3/8"F, 1/2"F and 3/4"F connection for iron pipe. Radiator connection prefitted with peroxide cured EPDM O-ring, DIN 2999 3/8"M, 1/2"M and 3/4"M conical thread. Valve body in chrome-plated CW617N brass. Double peroxide cured EPDM O-ring on the AISI 316 stainless steel stem. Max. working temperature 120 °C, max. pressure 10 bar, differential pressure 1 bar.

RS 202

Angle radiator valve, thermostatically or electronically controlled with white ABS protection cap. ISO 228/1 3/8"F, 1/2"F and 3/4"F connection for iron pipe. Radiator connection prefitted with peroxide cured EPDM O-ring, DIN 2999 3/8"M, 1/2"M and 3/4"M conical thread. Valve body in chrome-plated CW617N brass. Double peroxide cured EPDM O-ring on the AISI 316 stainless steel stem. Max. working temperature 120 °C, max. pressure 10 bar, differential pressure 1 bar.

RD 205

Straight radiator valve, thermostatically or electronically controlled with white ABS protection cap. ISO 228/1 3/8"F, 1/2"F and 3/4"F connection for iron pipe. 3/8"M, 1/2"M and 3/4"M radiator connection prefitted with peroxide cured EPDM O-ring, cylindrical thread and O-ring. Valve body in chrome-plated CW617N brass. Double peroxide cured EPDM O-ring on the AISI 316 stainless steel stem. Max. working temperature 120 °C, max. pressure 10 bar, differential pressure 1 bar.

RS 206

Angle radiator valve, thermostatically or electronically controlled with white ABS protection cap. ISO 228/1 3/8"F, 1/2"F and 3/4"F connection for iron pipe. 3/8"M, 1/2"M and 3/4"M radiator connection prefitted with peroxide cured EPDM O-ring, cylindrical thread and O-ring. Valve body in chrome-plated CW617N brass. Double peroxide cured EPDM O-ring on the AISI 316 stainless steel stem. Max. working temperature 120 °C, max. pressure 10 bar, differential pressure 1 bar.

RD 211

Straight radiator valve, thermostatically or electronically controlled with white ABS protection cap. Connection for copper, plastic and multilayer pipe W24x19. Radiator connection prefitted with peroxide cured EPDM O-ring, DIN 2999 3/8"M and 1/2"M conical thread. Valve body in chrome-plated CW617N brass. Double peroxide cured EPDM O-ring on the AISI 316 stainless steel stem. Max. working temperature 120 °C, max. pressure 10 bar, differential pressure 1 bar.

RS 212

Angle radiator valve, thermostatically or electronically controlled with white ABS protection cap. Connection for copper, plastic and multilayer pipe W24x19. Radiator connection prefitted with peroxide cured EPDM O-ring, DIN 2999 3/8"M and 1/2"M conical thread. Valve body in chrome-plated CW617N brass. Double peroxide cured EPDM O-ring on the AISI 316 stainless steel stem. Max. working temperature 120 °C, max. pressure 10 bar, differential pressure 1 bar.

RD 208

Straight radiator valve, thermostatically or electronically controlled with white ABS protection cap. Connection for copper, plastic and multilayer pipe W24x19. 3/8"M, 1/2"M and 3/4"M radiator connection prefitted with peroxide cured EPDM O-ring, cylindrical thread and O-ring. Valve body in chrome-plated CW617N brass. Double peroxide cured EPDM O-ring on the AISI 316 stainless steel stem. Max. working temperature 120 °C, max. pressure 10 bar, differential pressure 1 bar.

RS 209

Angle radiator valve, thermostatically or electronically controlled with white ABS protection cap. Connection for copper, plastic and multilayer pipe W24x19. 3/8"M, 1/2"M and 3/4"M radiator connection prefitted with peroxide cured EPDM O-ring, cylindrical thread and O-ring. Valve body in chrome-plated CW617N brass. Double peroxide cured EPDM O-ring on the AISI 316 stainless steel stem. Max. working temperature 120 °C, max. pressure 10 bar, differential pressure 1 bar.

RD 211/A

Straight radiator valve, thermostatically or electronically controlled with white ABS protection cap. Connection for copper, plastic and multilayer pipe 3/4"M Eurokonus. Radiator connection prefitted with peroxide cured EPDM O-ring, DIN 2999 3/8"M and 1/2"M conical thread. Valve body in chrome-plated CW617N brass. Double peroxide cured EPDM O-ring on the AISI 316 stainless steel stem. Max. working temperature 120 °C, max. pressure 10 bar, differential pressure 1 bar.

RS 212/A

Angle radiator valve, thermostatically or electronically controlled with white ABS protection cap. Connection for copper, plastic and multilayer pipe 3/4"M Eurokonus. Radiator connection prefitted with peroxide cured EPDM O-ring, DIN 2999 3/8"M and 1/2"M conical thread. Valve body in chrome-plated CW617N brass. Double peroxide cured EPDM O-ring on the AISI 316 stainless steel stem. Max. working temperature 120 °C, max. pressure 10 bar, differential pressure 1 bar.

RD 208/A

Straight radiator valve, thermostatically or electronically controlled with white ABS protection cap. Connection for copper, plastic and multilayer pipe 3/4"M Eurokonus. 3/8"M, 1/2"M and 3/4"M radiator connection prefitted with peroxide cured EPDM O-ring, cylindrical thread and O-ring. Valve body in chrome-plated CW617N brass. Double peroxide cured EPDM O-ring on the AISI

316 stainless steel stem. Max. working temperature 120 °C, max. pressure 10 bar, differential pressure 1 bar.

RS 209/A

Angle radiator valve, thermostatically or electronically controlled with white ABS protection cap. Connection for copper, plastic and multilayer pipe 3/4" M Eurokonus. 3/8" M, 1/2" M and 3/4" M radiator connection prefitted with peroxide cured EPDM O-ring, cylindrical thread and O-ring. Valve body in chrome-plated CW617N brass. Double peroxide cured EPDM O-ring on the AISI 316 stainless steel stem. Max. working temperature 120 °C, max. pressure 10 bar, differential pressure 1 bar.

RD 2501

Straight radiator valve, thermostatically or electronically controlled, with anti-loosening white ABS manual control knob. ISO 228/1 3/8" F, 1/2" F and 3/4" F connection for iron pipe. Radiator connection prefitted with peroxide cured EPDM O-ring, DIN 2999 3/8" M, 1/2" M and 3/4" M conical thread. Valve body in chrome-plated CW617N brass. Double peroxide cured EPDM O-ring on the AISI 316 stainless steel stem. Max. working temperature 120 °C, max. pressure 10 bar, differential pressure 1 bar.

RS 2502

Angle radiator valve, thermostatically or electronically controlled, with anti-loosening white ABS manual control knob. ISO 228/1 3/8" F, 1/2" F and 3/4" F connection for iron pipe. Radiator connection prefitted with peroxide cured EPDM O-ring, DIN 2999 3/8" M, 1/2" M and 3/4" M conical thread. Valve body in chrome-plated CW617N brass. Double peroxide cured EPDM O-ring on the AISI 316 stainless steel stem. Max. working temperature 120 °C, max. pressure 10 bar, differential pressure 1 bar.

RD 2505

Straight radiator valve, thermostatically or electronically controlled, with anti-loosening white ABS manual control knob. ISO 228/1 3/8" F and 1/2" F connection for iron pipe. 3/8" M, 1/2" M and 3/4" M radiator connection prefitted with peroxide cured EPDM O-ring, cylindrical thread and O-ring. Valve body in chrome-plated CW617N brass. Double peroxide cured EPDM O-ring on the AISI 316 stainless steel stem. Max. working temperature 120 °C, max. pressure 10 bar, differential pressure 1 bar.

RS 2506

Angle radiator valve, thermostatically or electronically controlled, with anti-loosening white ABS manual control knob. ISO 228/1 3/8" F and 1/2" F connection for iron pipe. 3/8" M, 1/2" M and 3/4" M radiator connection prefitted with peroxide cured EPDM O-ring, cylindrical thread and O-ring. Valve body in chrome-plated CW617N brass. Double peroxide cured EPDM O-ring on the AISI 316 stainless steel stem. Max. working temperature 120 °C, max. pressure 10 bar, differential pressure 1 bar.

RD 2511

Straight radiator valve, thermostatically or electronically controlled, with anti-loosening white ABS manual control knob. Connection for copper, plastic and multilayer pipe W24x19. Radiator connection prefitted with peroxide cured EPDM O-ring, DIN 2999 3/8" M and 1/2" M conical thread. Valve body in chrome-plated CW617N brass. Double peroxide cured EPDM O-ring on the AISI 316 stainless steel stem. Max. working temperature 120 °C, max. pressure 10 bar, differential pressure 1 bar.

RS 2512

Angle radiator valve, thermostatically or electronically controlled, with anti-loosening white ABS manual control knob. Connection for copper, plastic and multilayer pipe W24x19. Radiator connection prefitted with peroxide cured EPDM O-ring, DIN 2999 3/8" M and 1/2" M conical thread. Valve body in chrome-plated CW617N brass. Double peroxide cured EPDM O-ring on the AISI 316 stainless steel stem. Max. working temperature 120 °C, max. pressure 10 bar, differential pressure 1 bar.

RD 2508

Straight radiator valve, thermostatically or electronically controlled, with anti-loosening white ABS manual control knob. Connection for copper, plastic and multilayer pipe W24x19. 3/8" M, 1/2" M and 3/4" M radiator connection prefitted with peroxide cured EPDM O-ring, cylindrical thread and O-ring. Valve body in chrome-plated CW617N brass. Double peroxide cured EPDM O-ring on the AISI 316 stainless steel stem. Max. working temperature 120 °C, max. pressure 10 bar, differential pressure 1 bar.

RS 2509

Angle radiator valve, thermostatically or electronically controlled, with anti-loosening white ABS manual control knob. Connection for copper, plastic and multilayer pipe W24x19. 3/8" M, 1/2" M and 3/4" M radiator connection prefitted with peroxide cured EPDM O-ring, cylindrical thread and O-ring. Valve body in chrome-plated CW617N brass. Double peroxide cured EPDM O-ring on the AISI 316 stainless steel stem. Max. working temperature 120 °C, max. pressure 10 bar, differential pressure 1 bar.

RD 2508/A

Straight radiator valve, thermostatically or electronically controlled, with anti-loosening white ABS manual control knob. Connection for copper, plastic and multilayer pipe 3/4" M Eurokonus. 3/8" M, 1/2" M and 3/4" M radiator connection prefitted with peroxide cured EPDM O-ring, cylindrical thread and O-ring. Valve body in chrome-plated CW617N brass. Double peroxide cured EPDM O-ring on the AISI 316 stainless steel stem. Max. working temperature 120 °C, max. pressure 10 bar, differential pressure 1 bar.

RS 2509/A

Angle radiator valve, thermostatically or electronically controlled, with anti-loosening white ABS manual control knob. Connection for copper, plastic and multilayer pipe 3/4" M Eurokonus. 3/8" M, 1/2" M and 3/4" M radiator connection prefitted with peroxide cured EPDM O-ring, cylindrical thread and O-ring. Valve body in chrome-plated CW617N brass. Double peroxide cured EPDM O-ring on the AISI 316 stainless steel stem. Max. working temperature 120 °C, max. pressure 10 bar, differential

pressure 1 bar.

RD 2511/A

Straight radiator valve, thermostatically or electronically controlled, with anti-loosening white ABS manual control knob. Connection for copper, plastic and multilayer pipe 3/4" M Eurokonus. Radiator connection prefitted with peroxide cured EPDM O-ring, DIN 2999 1/2" M conical thread. Valve body in chrome-plated CW617N brass. Double peroxide cured EPDM O-ring on the AISI 316 stainless steel stem. Max. working temperature 120 °C, max. pressure 10 bar, differential pressure 1 bar.

RS 2512/A

Angle radiator valve, thermostatically or electronically controlled, with anti-loosening white ABS manual control knob. Connection for copper, plastic and multilayer pipe 3/4" M Eurokonus. Radiator connection prefitted with peroxide cured EPDM O-ring, DIN 2999 3/8" M and 1/2" M conical thread. Valve body in chrome-plated CW617N brass. Double peroxide cured EPDM O-ring on the AISI 316 stainless steel stem. Max. working temperature 120 °C, max. pressure 10 bar, differential pressure 1 bar.

M 320

Reverse angle radiator valve, thermostatically or electronically controlled with white ABS protection cap. Connection for copper, plastic and multilayer pipe W24x19. Radiator connection prefitted with peroxide cured EPDM O-ring, DIN 2999 1/2" M conical thread. Valve body in chrome-plated CW617N brass. Double peroxide cured EPDM O-ring on the AISI 316 stainless steel stem. Max. working temperature 120 °C, max. pressure 10 bar, differential pressure 1 bar.

M 320/A

Reverse angle radiator valve, thermostatically or electronically controlled with white ABS protection cap. Connection for copper, plastic and multilayer pipe 3/4" M Eurokonus. Radiator connection prefitted with peroxide cured EPDM O-ring, DIN 2999 1/2" M conical thread. Valve body in chrome-plated CW617N brass. Double peroxide cured EPDM O-ring on the AISI 316 stainless steel stem. Max. working temperature 120 °C, max. pressure 10 bar, differential pressure 1 bar.

M 330

Reverse angle radiator valve, thermostatically or electronically controlled, with anti-loosening white ABS manual control knob. Connection for copper, plastic and multilayer pipe W24x19. Radiator connection prefitted with peroxide cured EPDM O-ring, DIN 2999 1/2" M conical thread. Valve body in chrome-plated CW617N brass. Double peroxide cured EPDM O-ring on the AISI 316 stainless steel stem. Max. working temperature 120 °C, max. pressure 10 bar, differential pressure 1 bar.

M 330/A

Reverse angle radiator valve, thermostatically or electronically controlled, with anti-loosening white ABS manual control knob. Connection for copper, plastic and multilayer pipe 3/4" M Eurokonus. Radiator connection prefitted with peroxide cured EPDM O-ring, DIN 2999 1/2" M conical thread. Valve body in chrome-plated CW617N brass. Double peroxide cured EPDM O-ring on the AISI 316 stainless steel stem. Max. working temperature 120 °C, max. pressure 10 bar, differential pressure 1 bar.

M 322

Reverse angle radiator valve, thermostatically or electronically controlled with white ABS protection cap. ISO 228/1 1/2" F connection for iron pipe. Radiator connection prefitted with peroxide cured EPDM O-ring, DIN 2999 1/2" M conical thread. Valve body in chrome-plated CW617N brass. Double peroxide cured EPDM O-ring on the AISI 316 stainless steel stem. Max. working temperature 120 °C, max. pressure 10 bar, differential pressure 1 bar.

M 332

Reverse angle radiator valve, thermostatically or electronically controlled, with anti-loosening white ABS manual control knob. ISO 228/1 1/2" F connection for iron pipe. Radiator connection prefitted with peroxide cured EPDM O-ring, DIN 2999 1/2" M conical thread. Valve body in chrome-plated CW617N brass. Double peroxide cured EPDM O-ring on the AISI 316 stainless steel stem. Max. working temperature 120 °C, max. pressure 10 bar, differential pressure 1 bar.



Luxor S.p.A.

Sede amministrativa, stabilimento e uffici commerciali:

Administrative office, factory and commercial office:

Tel.: 030-9961161 – Fax: 030-9961165

info@luxor.it – www.luxor.it

via Madonnina, 94 – 25018 Montichiari - (BS) Italy

*Luxor si riserva il diritto di apportare miglioramenti e modifiche ai prodotti descritti ed ai relativi dati tecnici in qualsiasi momento e senza preavviso -
Luxor reserves the right to ameliorate and modify the above products and their technical data at any time and without notice*