



PRODUCTS CATALOGUE

2018

CHIMNEY
CLEANING
PRODUCTS

STOVE
ACCESSORIES

MAINTENANCE
PRODUCTS

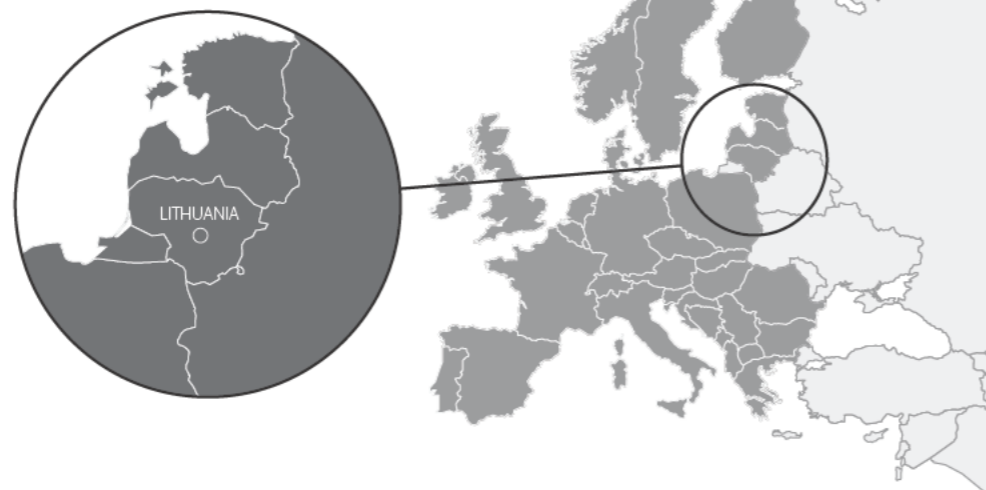

ABOUT HANSA

Company was founded in Lithuania in 1999 with help of German partners. Company started production and offered for local market its first accessories to use with heating appliances. All the production was based on German experience and traditions. It was very advanced step since local market was not so much familiar with the latest heating technologies and had no such products made locally.

TECHNOLOGY

Only the newest and most advanced technologies that meet the global standards and ensure high quality of products are used for HANSA researches, development and production.

ECOLOGY

Exhaustive researches allow HANSA to offer only responsibly selected products, produced exclusively from environmentally-friendly materials. Usage of these products not only causes no harm to environment, but often helps to reduce pollution in living environment.

PRODUCTS

In our days of fast evolution of high technologies HANSA focuses in creation of innovative and high quality products to match lifestyle and comfort needs of a modern person. Every new idea, research and step HANSA makes is because of its customers. Each product must be effective, understandable and easy to use by any user regardless his experience. Sincere work in this field result that range of company products today is far beyond the boundaries of accessories for heating devices. And sale points of the products long ago crossed borders of Lithuanian market. Now HANSA products are well known in many European countries.

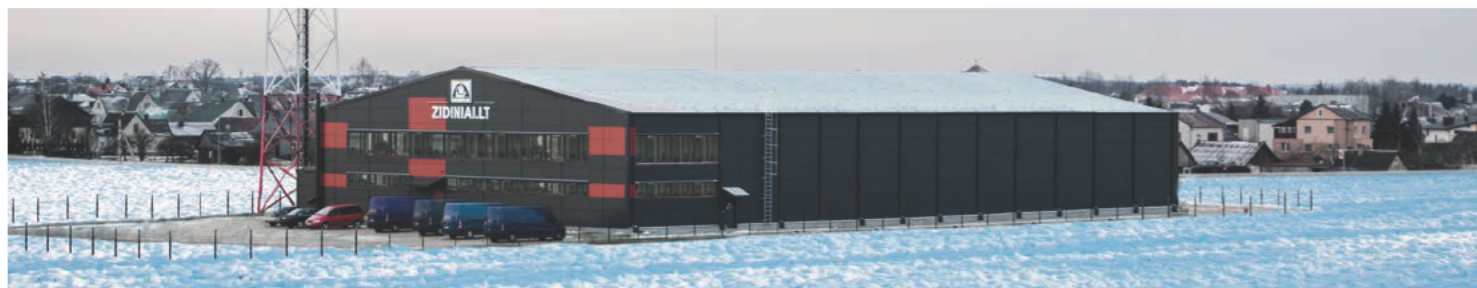

Topolių g. 6, Rumšiškės, LT-5633 Kaišiadorių r., Lithuania
Tel/fax +370 37 750 500 | info@hansaflame.com | www.hansaflame.com



Our contacts (VCard)



Our GPS coordinates

CONTENTS



Chimney cleaning products	4
Stove glass cleaning products	16
Stove accessories	18
Fire tools and sets	26
Log baskets	38
Maintenance products	44
Fire starters	48
Garden and household products	50





Soot and creosote released together with smoke present the greatest danger. Water vapour, which is released during timber combustion process, bond them together. HANSA EFFECTIVE SOOT REMOVER consists of a special blend of crystals. Some components of this blend have a catalytic effect on firewood combustion process – they break down the resins contained in the timber into the flammable gases, whilst other components at high temperatures release the gases, which react with tar deposits and destroy their structure. This causes complete evaporation of water – the major component to maintain the firmness of tar. Only brittle residues of tar are left: finer particles are exhaust through the chimney, whilst the bigger ones crumble down, undergo thermal decomposition and burn down. The efficiency of HANSA EFFECTIVE SOOT REMOVER has been certified by laboratory tests.

Regular use of HANSA EFFECTIVE SOOT REMOVER can ensure:

- Constant cleanliness of your heating device and chimney;
- Enhanced efficiency and capacity of your heating device and safety of the entire heating system;
- Reduced fuel consumption;
- Increased life-time of your heating device.



1. HANSA EFFECTIVE SOOT REMOVER can act efficiently only when complete chemical reaction in actively burning fire occurs. Therefore, pour soot remover before you fire your heating device.



2. Active substances released from soot remover during the combustion process cover the built-up tar residues and destroy their structure.



3. Tar residues exposed to and affected by active substances become brittle. Finer particles are exhaust through the chimney, whilst the bigger ones crumble down and burn down. Cleaning effect of EFFECTIVE SOOT REMOVER lasts for several days.



CONCENTRATED soot remover

Weight	Art no	Barcode
1 kg	110	4779022360183
500 g	111	4779022360572

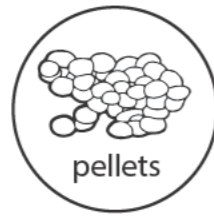

CONCENTRATED soot removing pellets

Weight	Art no	Barcode
1 kg	114	4779022360497
500 g	117	4779022361401



"Vitamins" for solid fuel

Quantity	Art no	Barcode
50 sachets	120	4779022360367
25 sachets	121	4779022361395



CONCENTRATED chimney sweep log

Weight	Art no	Barcode
1,1 kg	113	4779022360237



CONCENTRATED soot remover

Quantity	Art no	Barcode
10 sachets by 50 g	112	4779022360176
5 sachets by 50 g	118	4779022361357
5 sachets by 18 g	115	4779022361326
5 sachets by 5 g	116	4779022361333



Soot remover

Weight	Art no	barcode
1 kg	100	4779022360763
500 g	101	4779022361340

Soot removers comparison

- ★ Product fit well
- ★ Product fit perfect

Products	SOOT REMOVER	CONCENTRATED SOOT REMOVER POWDER	CONCENTRATED SOOT REMOVING PELLETS	CONCENTRATED SOOT REMOVER (IN SACHETS)	CONCENTRATED CHIMNEY SWEEP LOG	"VITAMINS" FOR SOLID FUEL
						
	 powder	 powder	 pellets	 sachets	 long burning log	 sachets
STOVE FIREPLACE 	★ ★	★ ★	★ ★	★ ★ ★	★ ★ ★	★ ★ ★
WOOD GASIFICATION STOVE 	★ ★ ★	★ ★ ★	★ ★ ★	★ ★	★ ★	★ ★ ★
PELLET HEATING DEVICE 	-	-	★ ★ ★	-	-	-
Exclusive features		Contains 4 times more active substances	Contains 4 times more active substances	Contains 4 times more active substances	Contains 4 times more active substances	Helps to get up to 5-40% more heat, then using wet fuel



ROTARY

sweeping POWER

- ▶ durable
- ▶ elastic
- ▶ chemically resistant

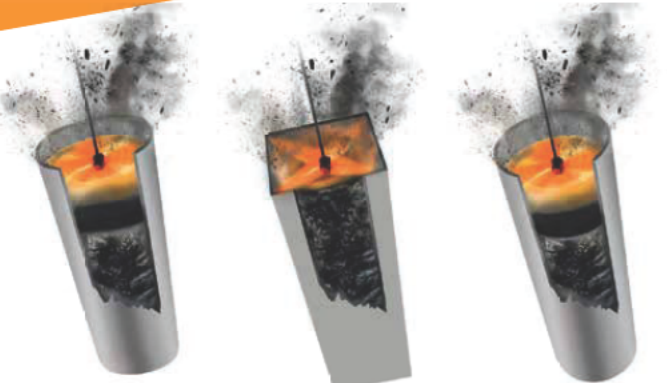
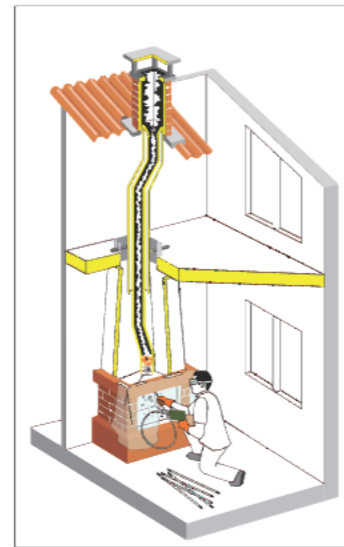
Take one rod and attach the brush. To do this, click on the button at the end of the rod and insert the rod into the brush. Make sure that the handle and the brush is securely fastened.

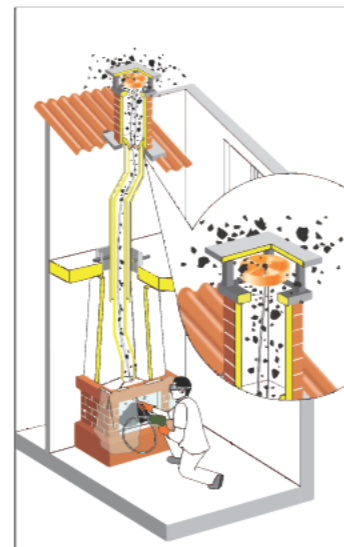

Attach the drill to the end of the last rod and slowly push the rods up the chimney. After cleaning first section of chimney turn off the drill, without pulling the rod and repeat the procedure until you reach the top. Then after reaching the top of the chimney switch the drill to rotate in the opposite direction and pull the rods down and out. Bristle movement in the opposite direction will help clean hard.

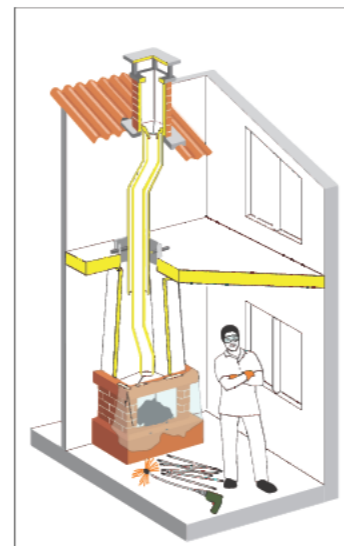

TORNADO - it is easy to assemble, reliable and durable set for cleaning chimneys. It lets you quickly and easily cleans the chimney yourself.

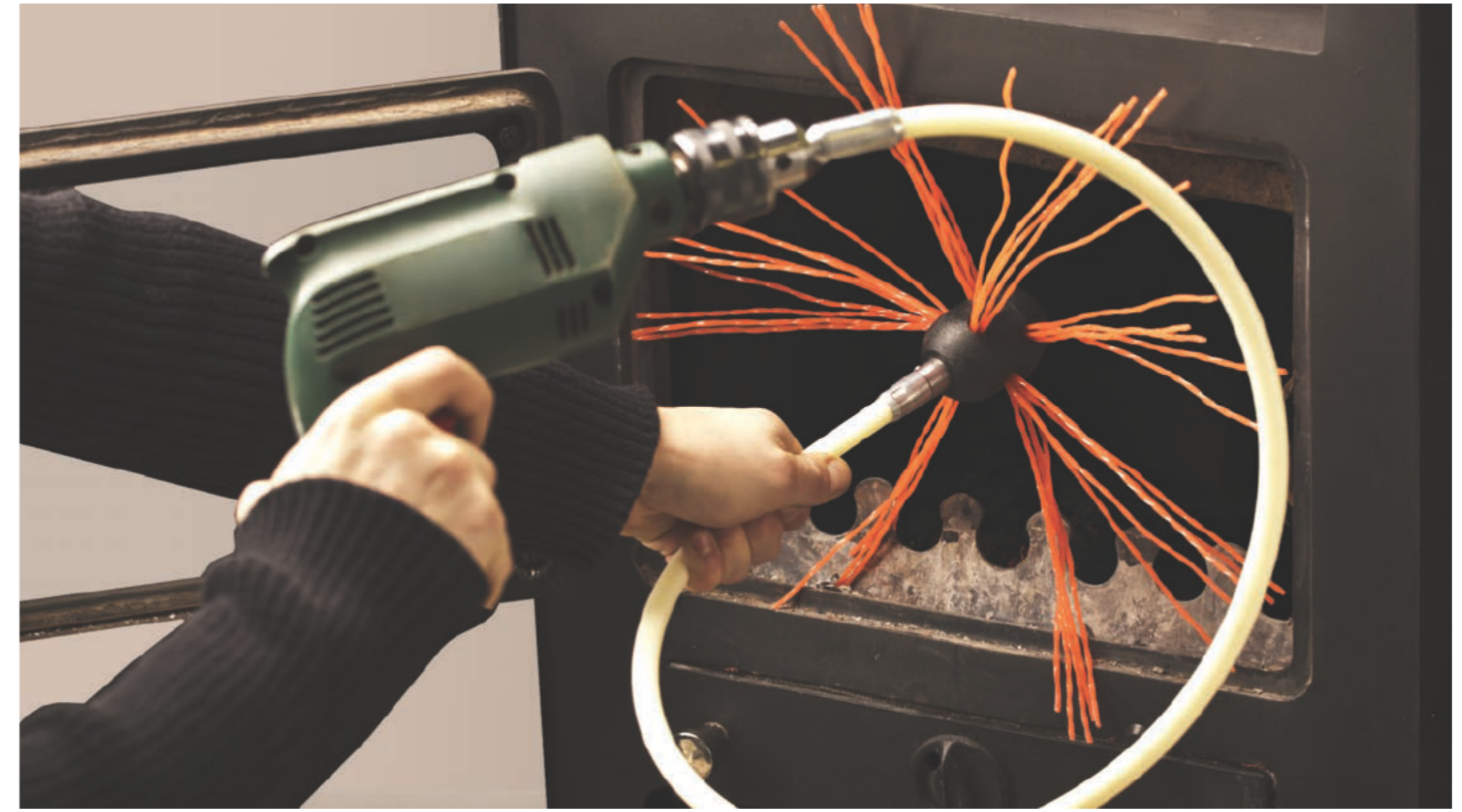

Tornado
rotary chimney sweeping kit



It is easy to assemble, reliable and durable set for cleaning chimneys. It lets you quickly and easily cleans the chimney yourself. Carefully tending the flue system and periodical use of Tornado, you will increase the efficiency of the stove and protect your home from the threat of chimney fire.



Length	Art no	Barcode
6-metre	150	4779022360596
8-metre	151	4779022361128
10-metre	152	4779022361135
12-metre	153	4779022361142

Rotary heads offers to transform a mechanical cleaning rods to a rotary and rotating chimney cleaning set. The chain and cable heads is used for thorough cleaning of traditional brick and stoneware chimneys as well as heavy deposits including bird nests and tar. The nylon head is used for effective chimney sweeping. The rotary sweeping heads works by connecting the rods to any electrical drill. When connected to the drill the brush can rotate from a few hundred to several thousand revolutions per minute (depending on the power of the drill). The rotary heads can clean the chimney to the bare brick. With the help of large rotational force Hansa rotary heads removes even the most stubborn build up inside any flue or chimney. Hansa rotary heads can be used only with universal M12 thread. It is necessary to pay special attention that the drill works only at the right speed as in the case of drilling (clockwise).



Rotary chain head, M12
For removing heavy deposits including bird nests and tar.

Art no	Barcode	Diameter when spinning
160	4779022361463	28 cm



Rotary cable head, M12
For removing heavy deposits including bird nests and tar.

Art no	Barcode	Diameter when spinning
161	4779022361470	35 cm

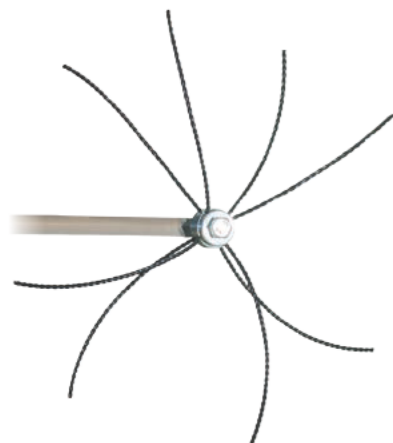

Rotary nylon head, M12
For effective chimney sweeping

Art no	Barcode	Diameter when spinning
162	4779022361487	40 cm

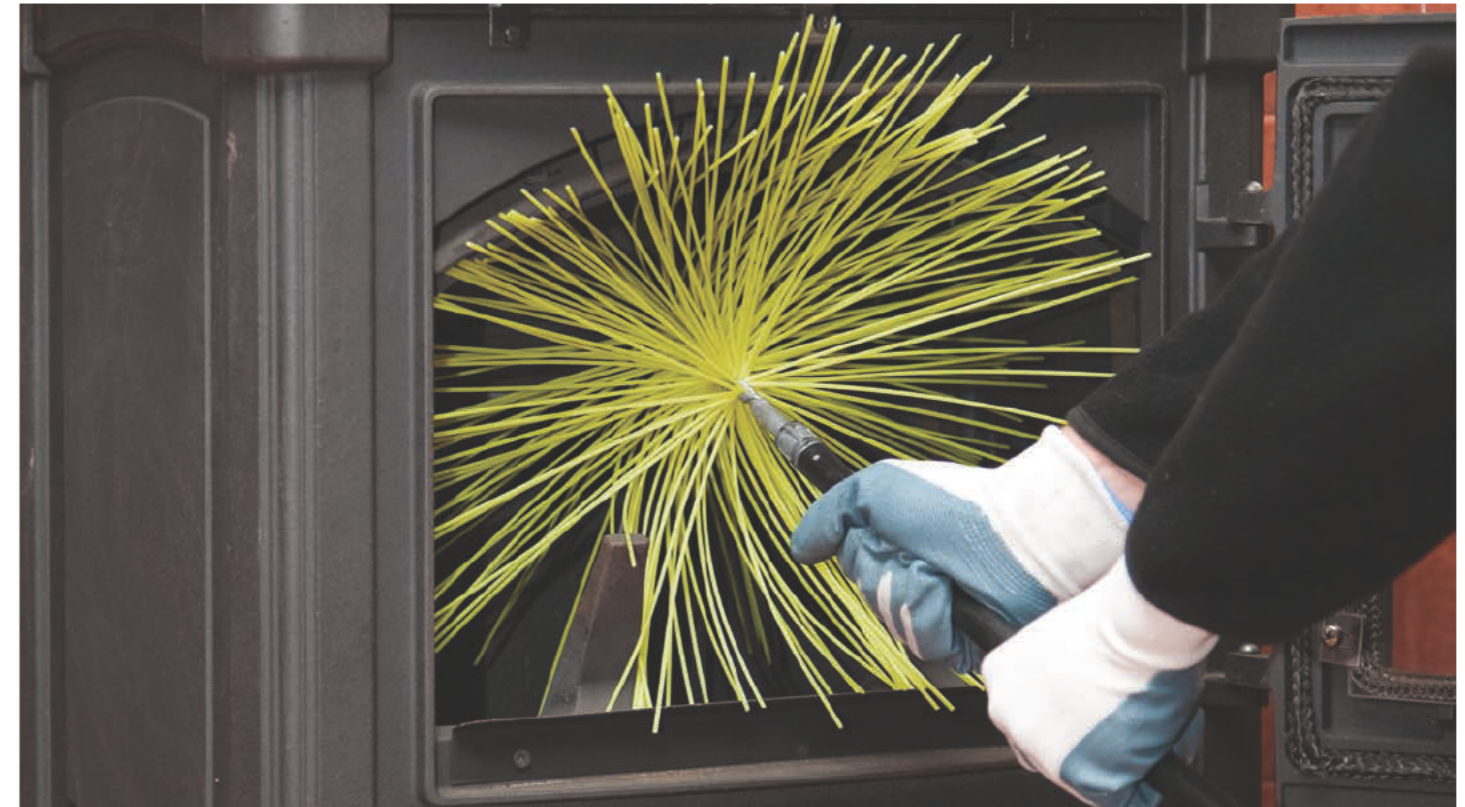

Universal chimney brush

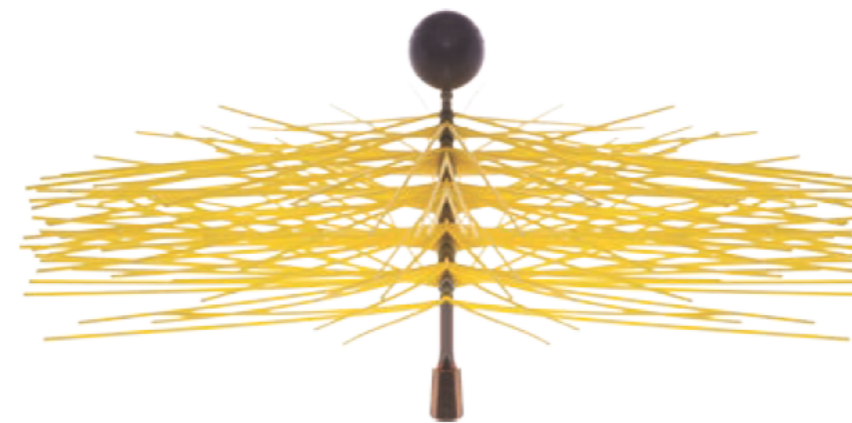

130

4779022360558

Chimney inner diameter range

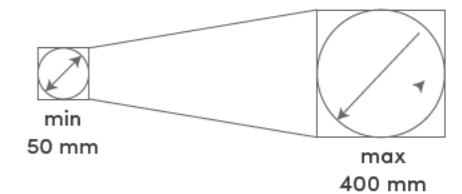

For cleaning of flues and chimneys. Suitable for any diameter and lengths chimneys and flues made of metal and bricks. Also suitable for curved chimneys and flues. It won't scratch internal walls of the chimney or flue. Diameter of the brush - 400 mm.

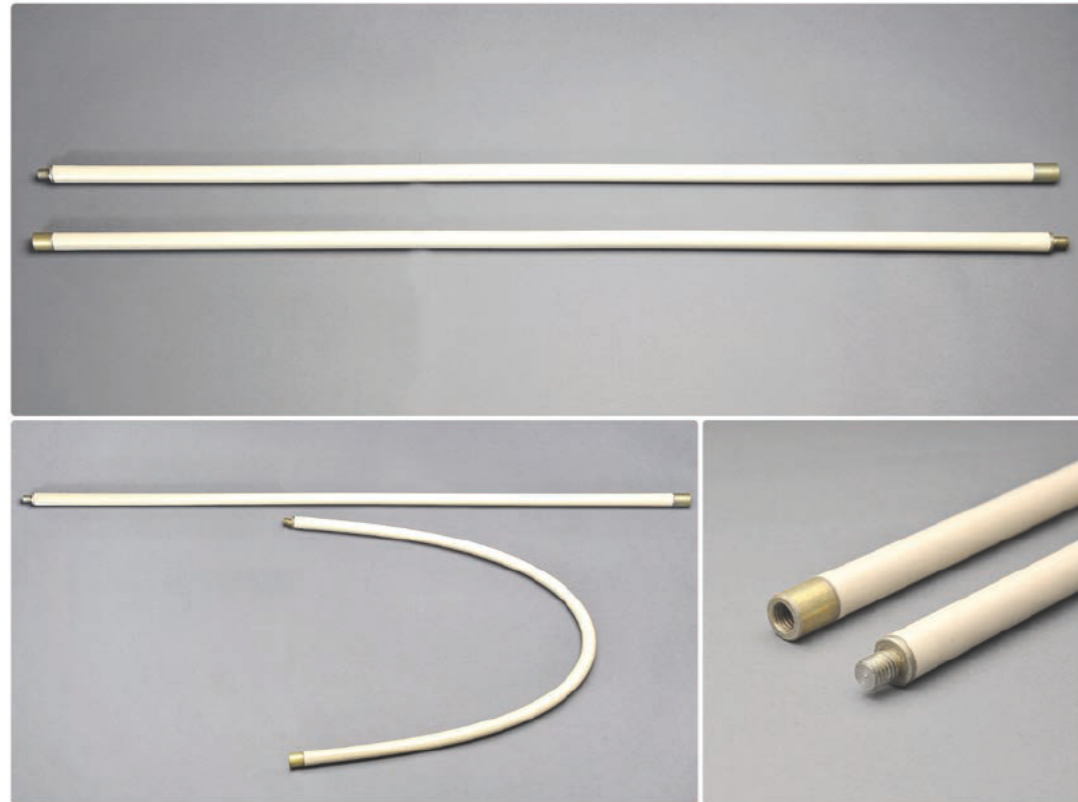

Made of strong and flexible plastic. Suitable for use at negative temperatures. Do not break. Designed for chimney cleaning both from the bottom and from the top. Also can be used for cleaning of ventilation ducts, rainwater (drain) pipes and sewerage or wastewater systems. Rod joint thread size - M12

Chimney cleaning rod



Chimney cleaning rods set



6-metre SET

8,4-metre SET

Length	Art no	Barcode
1 m	140	4779022360831
1,4 m	141	4779022360848

Chimney cleaning rods set with carrying bag

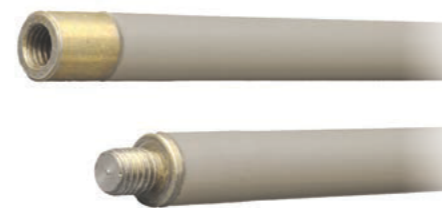

Incl. carrying bag



6-metre SET

8,4-metre SET

Length	Art no	Barcode
1 m x 6 pcs	144	4779022360541
1,4 m x 6 pcs	145	4779022361081

Chimney cleaning tools starter stand





ULTIMATE

Stove glass cleaner
Ultimate

Volume	Art no	Barcode
500 ml	200	4779022360152
1 000 ml	203	4779022361227



NOT IRRITATING TO SKIN

Stove glass cleaner
Foaming, not irritating to skin

Volume	Art no	Barcode
500 ml	201	4779022360626



FOAMING

Stove glass cleaner
Foaming, aerosol

Volume	Art no	Barcode
500 ml	202	4779022360169

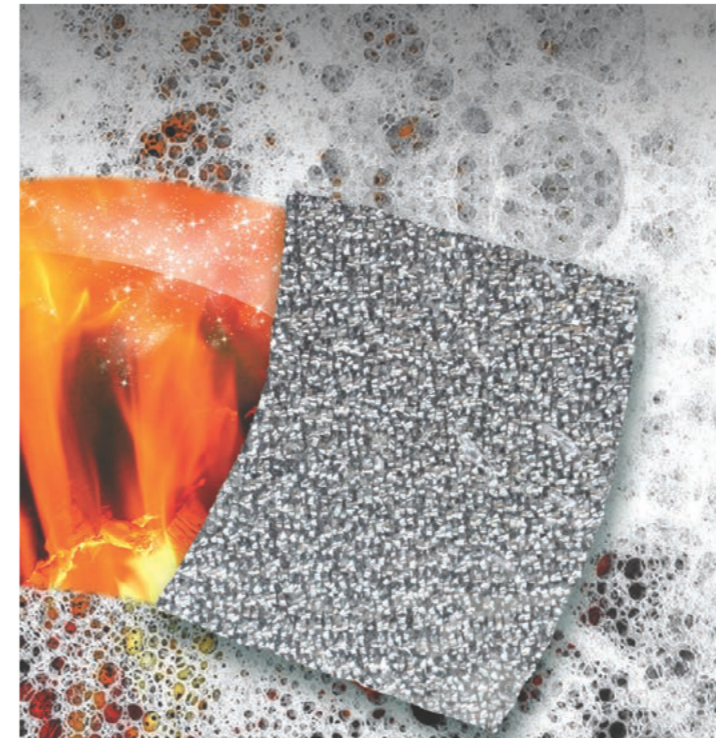

Wet cleaning

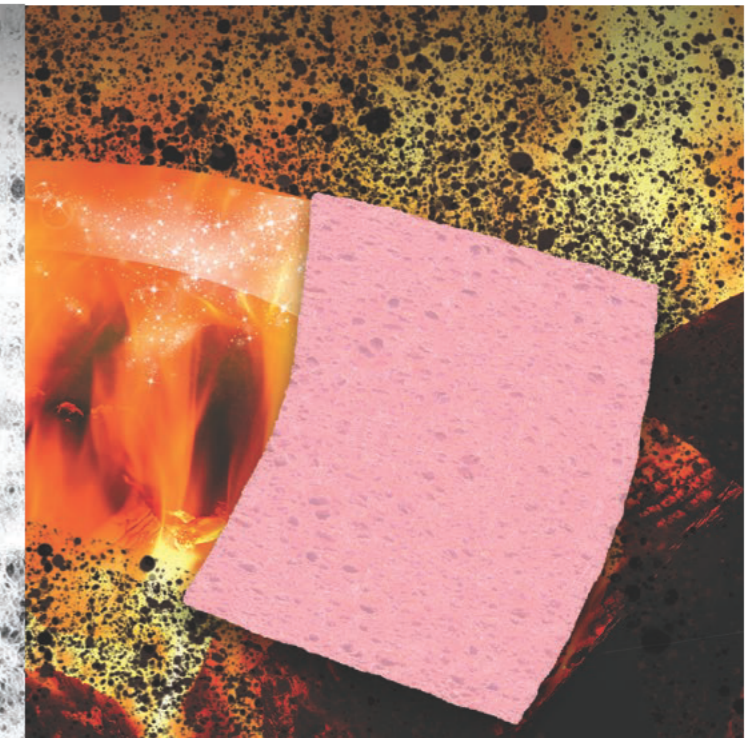

Dry cleaning

Stove glass cleaning sponge
One sponge - two ways of use



210 4779022360411



Rough side is made from a special plastic. Bristles are sharp enough to remove a thin, newly appeared layer of soot and same time they are soft to the glass surface to not leave scratches. By the way, plastic bristles are resistant to moisture, so sponge staying free of rust for a long time.

Soft side is made of special cellulose. It's resistant to the detergent containing active substances contained in it long remain durable. In addition, it is a large internal volume and extremely strong absorptive power. It's therefore perfectly absorbs dirt on the glass without leaving residue of soot or detergent deposits.



DESIGN
LOW CENTRE OF GRAVITY Due to its low centre of gravity, SIROCCO fan can be steadily and securely positioned on a stove.
BLACK FRAME Black colour of the fan perfectly matches with different colours of stoves.
ALUMINIUM COLOUR BLADES Aluminium colour fan blades can be easily noticed when rotating.

ADVANTAGES
UNIVERSAL Can be used with all types of stoves: cast iron, stainless steel, tile or stone.
OPERATES WITHOUT NOISE
UP TO 30% MORE HEAT Sirocco fan allows heating room up to 30% faster.
UP TO 20% LESS FUEL CONSUMPTION Sirocco fan allows saving up to 20% of stove fuel.

TECHNOLOGY
FREE OPERATION No need to use batteries or power cords; operates by using thermal energy.
READY TO USE You only need to unpack and put onto a stove.
OPERATES FROM 50°C Operation starts within 1 min., when stove surface heats up to 50°C.
WITH ADJUSTABLE SCREW LEGS SIROCCO can be used on uneven surface or oblique stoves.

SIROCCO HISTORY The word SIROCCO comes from a Mediterranean region where it is known as a strong warm southern or south-easterly wind. It is formed when the hot air of Saharan desert moves across the Mediterranean and mixes with the cooler air of Europe thus creating counter clockwise circulation across the Med.

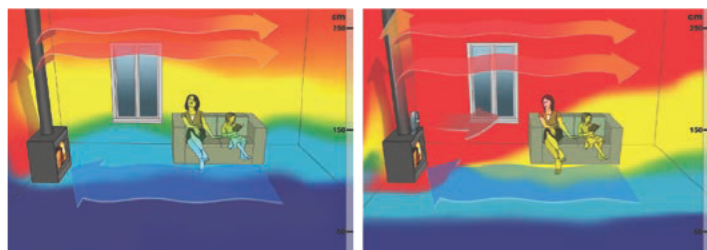

Air circulation without SIROCCO Air circulation with SIROCCO



Sirocco stove fan



400 4779022360589

Sirocco plus fireplace fan







401 4779022360817

Sirocco fix flue pipe fan

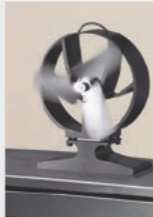

404 4779022361296

SIROCCO fan comparison

	 SIROCCO Stove fan	 SIROCCO PLUS Fireplace fan	 SIROCCO FIX Flue pipe fan
Standing on the top of Stove	●	●	●
Hanging on the doors of Fireplace		●	
Fixing to the chimney Flue pipe			●
What's in the box?	SIROCCO fan	SIROCCO fan Fireplace doors bracket	SIROCCO fan Flue pipe bracket
Use compatibility with	Cast iron stove Steel stove	Fireplace with the doors Stove (if no space on the top)	Tile stove Stone stove Single wall flue pipe
Item barcode	4779022360589	4779022360817	4779022361296
Highlight			



Stove thermometer
magnetic

Stove thermometer is designed to set combustion mode in heating units with single-layer metal chimney. Ideally, the stove thermometer should be installed in eye-level height, at least in 30cm distance from heating unit. If the stove thermometer is installed on stainless-steel chimney, you must choose the proper location and attach the stove thermometer using the supplied specific screw. If the stove thermometer is installed on stainless-steel chimney.

- 

Up to 120°C temperature: not completed combustion produces soot and creosote inside the stove. Deposits debris accumulates on interior walls of the stove and chimney and reduce chimney draught. Carbon gases intoxication hazard. It is recommended to slightly open the air-valve of the stove and/or add solid fuel.
- 

From 120°C to 320°C temperature: the stove is used safely and cost-efficiently. The fuel burns down completely; highest heating efficiency is achieved.
- 

Up to 320°C and higher temperature: hazard of ignition of deposits debris inside the chimney. Increased thermal losses due to high loss of heat through chimney. Reduced stove useful life. It is recommended to slightly close the air and draught valve of the stove.



410 4779022360565



Moisture meter
for wood and building materials



Device measures

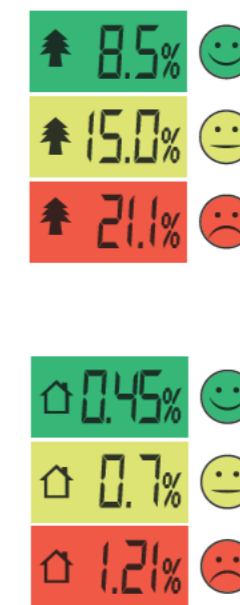

Wood moisture content

- Measurement range: from 8% to 60%
- Measurement precision: ±2%
- 3 colour backlight

Wood for burning shall have a maximum of 20%
Wood for indoor work shall have a maximum of 8%
Wood for outdoor work shall have a maximum of 12-16%

Building material moisture content

- Measurement range: from 0,3% to 2,0%
- Measurement precision: ±0,01%
- 3 colour backlight

Concrete moisture content shall not exceed 2%

411 4779022360633



Wood stove humidifier
suitable for aromatherapy



Stove humidifier takes old-fashioned steaming kettles to the next level, bringing less weight with stainless steel design which helps to have a quicker and lower boiling point to fit standards of modern heating devices which have reduced surface temperature, also stove humidifier comes in new appearance that stands out from the crowd and can be used in modern, minimalist and classic environment as well.

Advantages:

- Scents and perfume may be added to have a wonderful smell in the room
- Starts boiling faster than cast-iron kettles
- Made of stainless steel
- Add healthy moisture to dry room air while using a heating device.

480	4779022360633
capacity	1,2l



The combination of this scent and burning fireplace/stove will saturate your home with fragrant warmth. The scent is long lasting and charming! The secret of unforgettable sensations: the aroma blooms in the warmth of a fireplace and together with this warms spreads around in your home filling even the most remote corners.

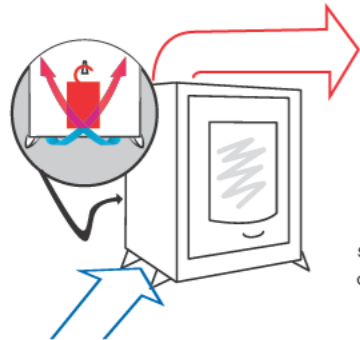

Suspend scented sachet on the bottom of the stove rear side.

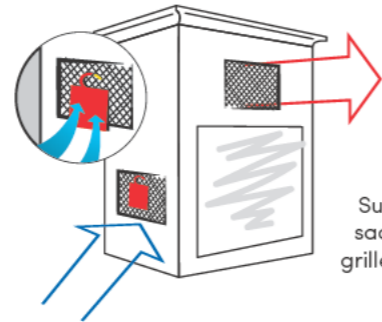

Suspend scented sachet on cold air grilles of a fireplace.

Stove scented sachet fruit paradise



710 4779022360855

Stove scented sachet mango



711 4779022360862

Stove scented sachet cinnamon-orange



712 4779022360879

Stove scented sachet vanilla



713 4779022360886

Stove scented sachet lavender



714 4779022360893

Stove scented sachet rose



715 4779022360909



Flaming rainbow
flame colouring stick



700 4779022360244

Flaming Rainbow is a unique product that will add enjoyment to any solid fuel fire! Everyone who enjoys a fire indoors and out, whether a camp fire, a garden fire pit or fireplace will love Flaming Rainbow. Turn any fire into a show of vibrant blue, green, purple and red. Delight your family, mystify your friends. Simply throw the entire stick into your fire and watch the transformation. Each pack will provide over half an hour of vivid entertainment.

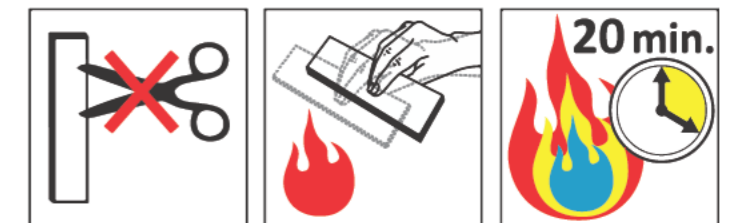



The famous medieval European trade league HANSA was surprising the coevals with its trade volumes, power, and goals; and its glory had distantly surpassed the time of the league. The famous name still is known as the synonym of quality, reliability, and durability. The inspiring activity of HANSA league instigated resurrecting from oblivion old traditions of guilds and following the smithery experience of one of the most powerful in the old league – the region of Saxony – introduces the handmade wrought fireplace tools.

Forged iron fire tools



600	60 cm (23.6")	601	60 cm (23.6")	602	60 cm (23.6")	603	60 cm (23.6")
-----	---------------	-----	---------------	-----	---------------	-----	---------------

2 Pin wall bracket



610		
	W	H
610	18 cm (7.1")	6 cm (2.4")

4 Pin wall bracket



611		
	W	H
611	36 cm (14.2")	6 cm (2.4")

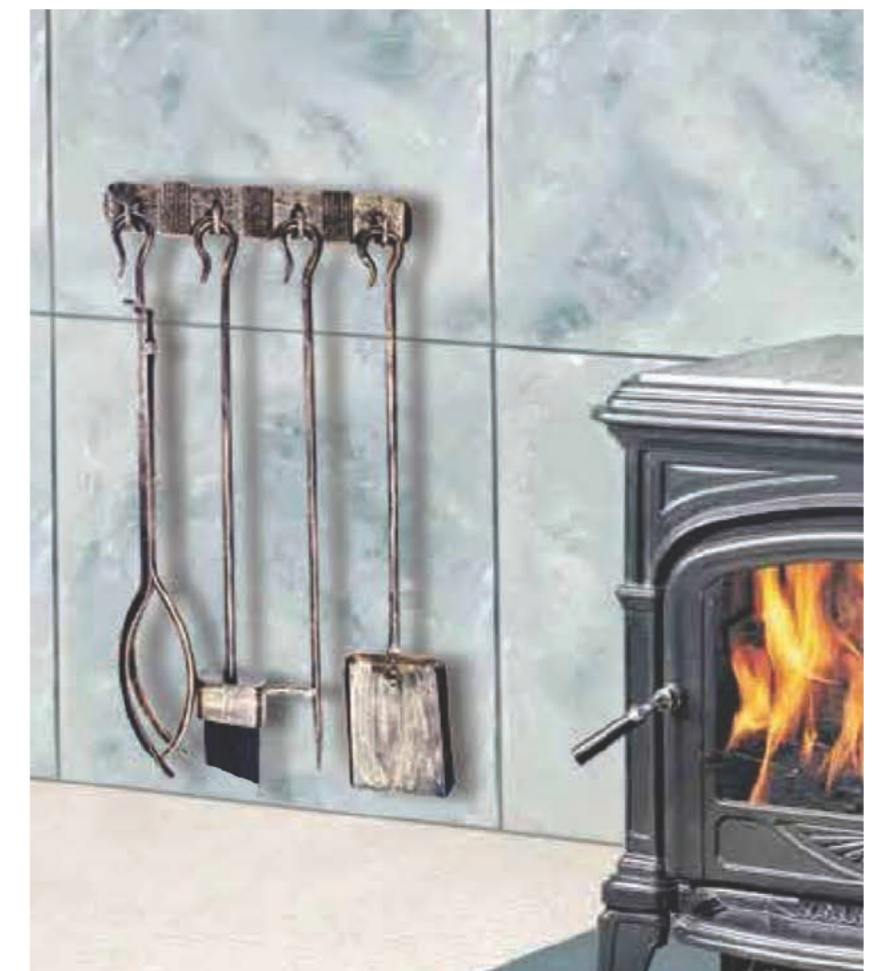



natural oak

Stainless steel and oak set
model Lina, series Round

Stainless steel and oak set
model Lina, series Wall



SET638

High- 71 cm (27,9")



SET637

High- 50 cm (19,7")



100%

 genuine
 leather

Stainless steel and leather set
 model Lina, series Round

Stainless steel and leather set
 model Lina, series Wall



SET648

High - 71 cm (27.9")



SET647

High - 50 cm (19.7")



high grade stainless steel

Stainless steel and oak fire tools LINA



630 50 cm (19.7") 631 50 cm (19.7") 632 50 cm (19.7") 633 50 cm (19.7")

Stainless steel fire tools LINA



620 50 cm (19.7") 621 50 cm (19.7") 622 50 cm (19.7") 623 50 cm (19.7")

Stainless steel set
model Lina, series Round



SET648 High - 71 cm (27.9")

Stainless steel set
model Lina, series Wall



SET647 High - 50 cm (19.7")

1 Pin wall bracket



624

	W	H
624	8 cm (3.1")	5 cm (1.9")

2 Pin wall bracket



625

	W	H
625	19 cm (7.5")	5 cm (1.9")

4 Pin wall bracket



626

	W	H
626	38 cm (14.9")	5 cm (1.9")



Stainless steel set
model Domas, series round

SET650

High - 54 cm (21,3")



Stainless steel set
model Domas, series square

SET651

High - 54 cm (21,3")



Log holder
made of stainless steel

652

High - 27 cm (10,6")



Hansa leather gloves were designed for safe use of outdoor appliances (such as outdoor BBQ, indoor and outdoor fireplaces, stoves, and cookers). The gloves protect hands from exposure to heat and fire, and help to avoid burns. The gloves are made of buffalo suede, which is durable and features excellent insulating qualities. The surface of these gloves is rough: it is convenient for holding even slick objects. The inner lining is made of soft, pleasant to touch 100% cotton layer. The gloves are resistant to heat from 100°C to 500°C, for 15 seconds per one contact.



Heat resistant gloves
Heat resistant up to 500°C

	Art no	Barcode
Pair	450	4779022361098
Left glove	451	4779022361104
Right glove	452	4779022361111



Made of high quality genuine leather. Designed for firewood, but also great for carrying magazines, newspapers and other things. This high-quality, durable construction, durable and capacious bag hold long and reliable.

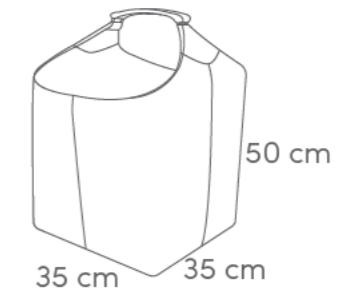

Log basket H1
Made of genuine leather

420 4779022360640

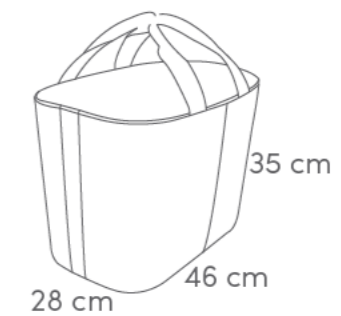

Log basket H2
Made of genuine leather

421 4779022360657

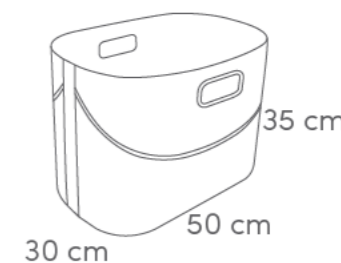

Log basket H3
Made of genuine leather

422 4779022360664



Silent burning wood crackle, aroma of fragrant heat and view of the fireplace. This is probably one of the most pleasant sensations that a user of fireplace or stove may experience in the cool evening. HANSA has created special bags for carrying and keeping firewood for preservation. Robust and comfortable bags make it even more easy to bring firewood to the fireplace. And the baskets that match the tastes and designs that make up the design adorn the room and keep it clean.



A one-for-all bag is made of durable and weather-resistant fabric for long lasting use. Suitable to carry firewood, purchases, tools, toys and more. Soft carrying handles do not scratch your hands. Comfortable side pockets for items. The bag is easy to fold. Can be washed.

Log basket C1
Made of faux leather

Log basket C2
Made of faux leather

Universal basket
Square

Universal basket
Round

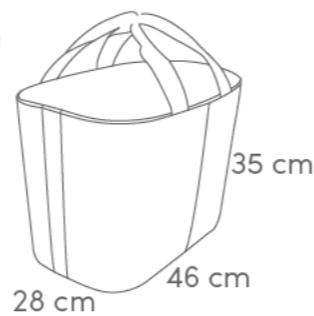
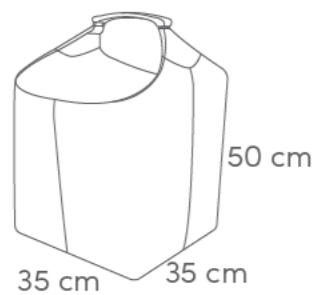

430

4779022360916

431

4779022360923

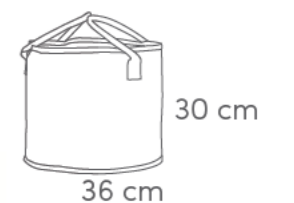

440

4779022360930

441

4779022360947

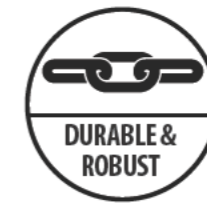

Rubber basket
Made from recycled tyres

Made from recycled tires, robust construction, capacious carrying basket. Resistant to moisture and frost, easy to clean, durable. Safe to use inside and out. Perfect for carrying and storing wood and other things.



440

4779022360930

ø 29 cm

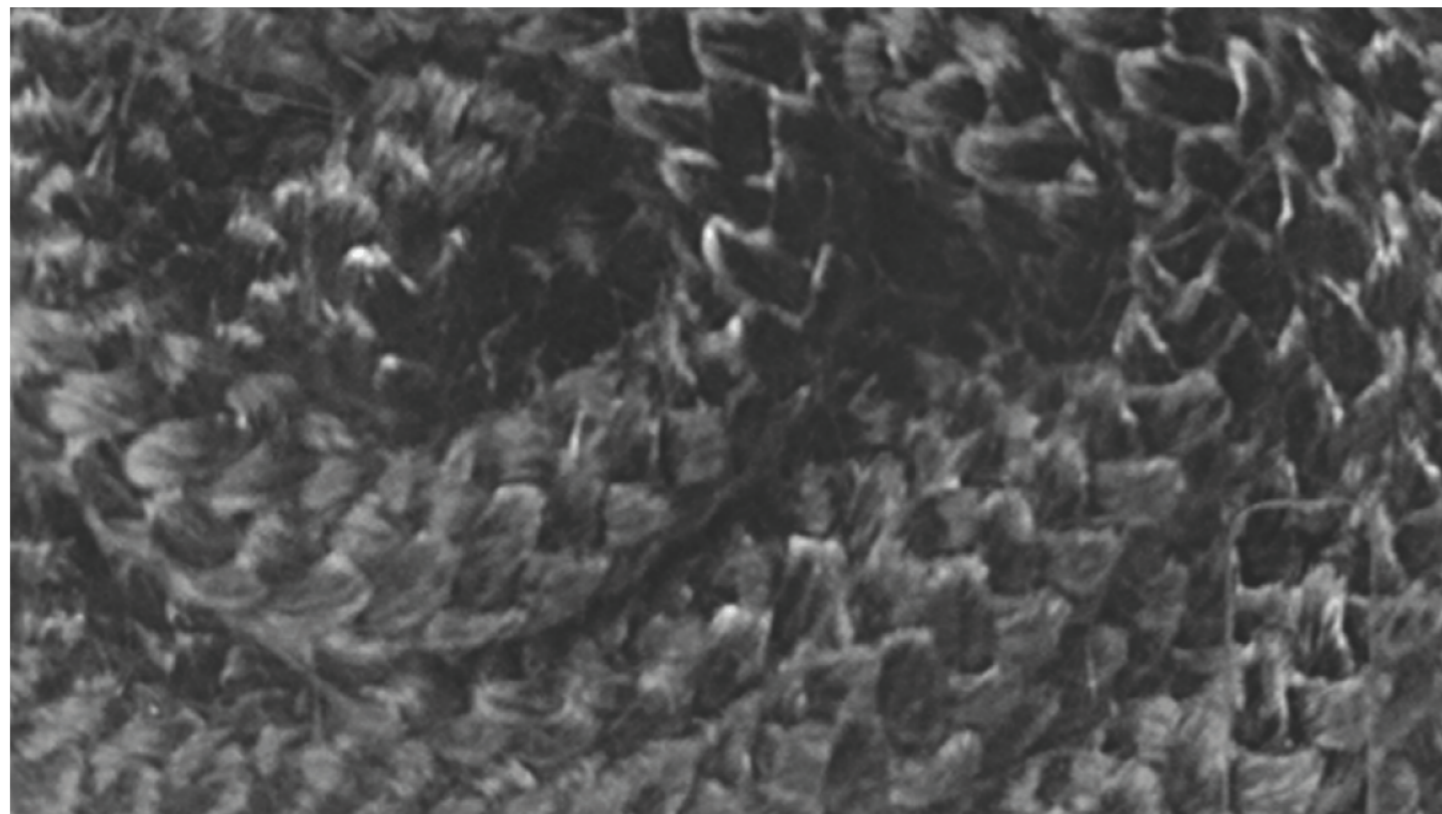

Heat resistant gasket for the doors of stoves, ovens and other heating devices. Heat resistance properties of the rope can withstand temperatures up to 850°C. Anthracite colour goes well with the typical dark colour stoves. Tight weave provides a rigid structure and a long reliable service life.

Ceramic fibre sealing strips
Anthracite colour, heat resistant up to 850°C



Measurements	Art no	Barcode
6 mm x 2,5 m	310	4779022360459
8 mm x 2,5 m	311	4779022360466
10 mm x 2,5 m	312	4779022360473
12 mm x 2,5 m	313	4779022360695
2 x 10 mm, self adhesive	314	4779022360480

Heat resistant glue
Heat resistant up to 1200°C



Volume	Art no	Barcode
17 ml	320	4779022360510



Protective varnish
Satin, heat resistant up to 450°C

HANSA heat resistant protective satin varnish is an easily applicable spray varnish for stoves, fireplaces, chimneys and fireplaces stones. When dry, this varnish forms slightly satin, thin yet extremely strong protective layer, which protects heating devices against stains, scratches and wear, while also enhancing the colour and structure. HANSA protective varnish is heat resistant up to 450°C.

400 ml	340	4779022361364
--------	-----	---------------



Heat resistant zinc
Heat resistant up to 300°C

The best way to prevent rust is to coat metal with an anti-corrosive coating. Zinc is the best material for the job, its resistance to salt and water corrosion is renowned. By coating metal with zinc, you will prolong the life of any metal object. Zinc is heat resistant up to 300°C

400 ml	301	4779022361364
--------	-----	---------------



Smoke capsules for checks
Up to 15 m³/capsule

Smoke capsules are intended for checking of:

- Chimney draughts and/or leak-proof
- Air ventilation draught and/or sealing
- Fire protection detectors performance
- Sewerage, drainage and storm water run pipe performance reliability.

6 pcs	330	4779022360619
-------	-----	---------------



These products are developed out of carefully tested raw materials that can resist a temperature of 800°C. Moreover, attention has also been paid to an optimum corrosion resistance. Excellent application where combinations of good corrosion resistance and heat resistance are primordial importance (i.e. stoves, fireplaces, chimneys, barbecues, exhausts...).

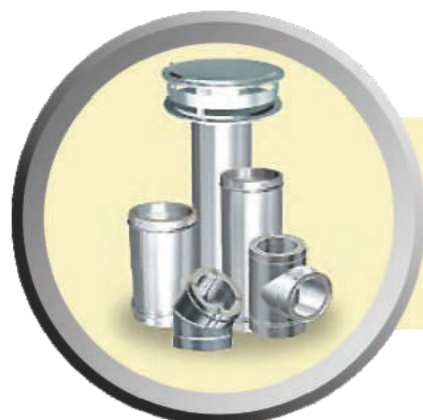

**EXCELLENT FOR PAINTING
STAINLESS STEEL**

901 Blue metallic



902 Green metallic



903 Grey brown metallic



910 Black



930 Anthracite



937 Dark anthracite



950 Black anthracite



960 Brown



970 Grey



980 White coffee



990 White

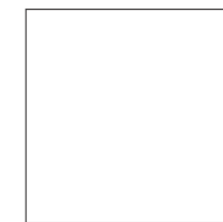

991 Red



993 Dark brown



994 Grey brown



996 Silver



997 Bronze



Stove paint

Heat resistant up to 800°C

Colour	Art no
Blue metallic	901
Green metallic	902
Grey brown metallic	903
Black	910
Anthracite	930
Dark anthracite	937
Black anthracite	950
Brown	960
Grey	970
White coffee	980
White	990
Red	991
Dark brown	993
Grey brown	994
Silver	996
Bronze	997

AVAILABLE IN VOLUMES



HEAT RESISTANT PAINT "HANSA" CAN BE USED ON THE FOLLOWING:



FIREPLACES

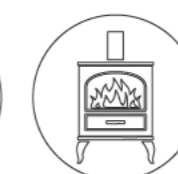

STOVE

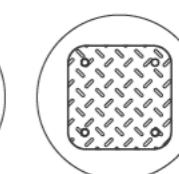

STAINLESS
STEEL

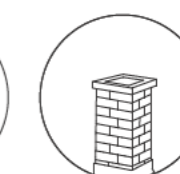

CHIMNEY
FLUES

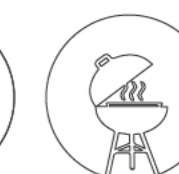

BBQ

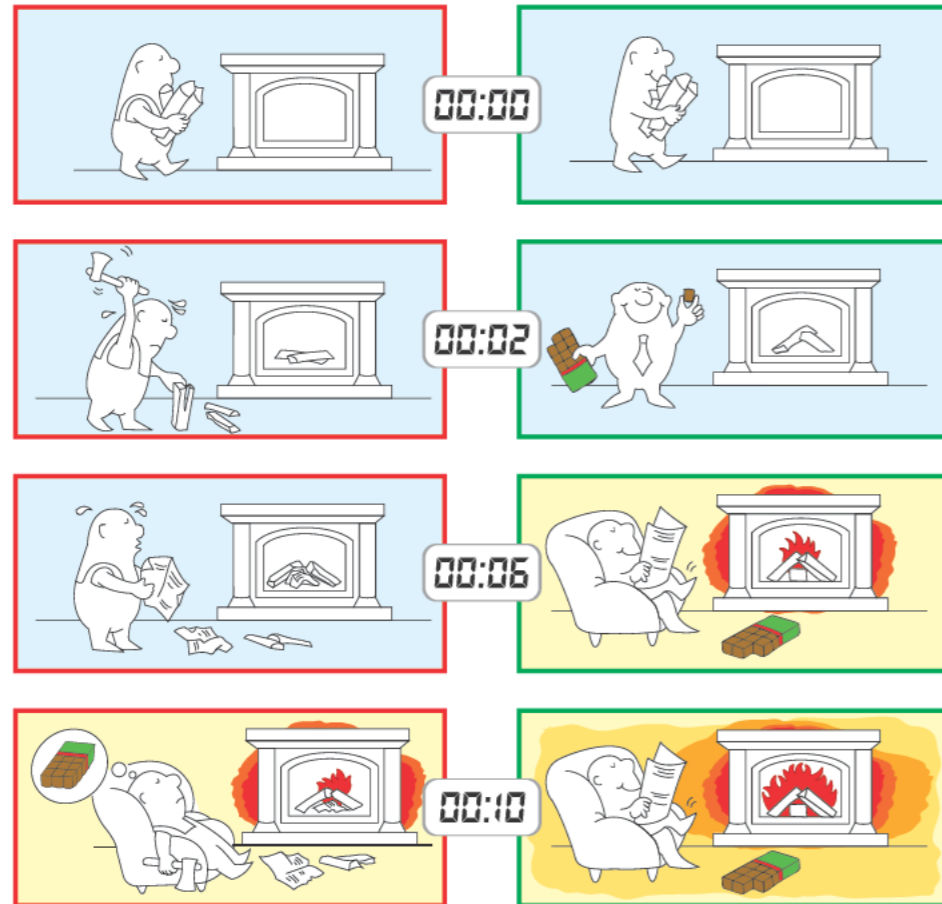

Clean and quick way to start a fire. Our superior firelighters are quick and reliable solution that will make lighting your fire a pleasure. They have a strong and long burn time and are quick and easy to light. Great for using in wood burning stove, fireplaces and lighting BBQ. They can even be used in wet and windy weather, so great for camping too.

Fire starters

Cut into pieces



Quantity	Art no	Barcode
50	500	4779022360794

Quantity	Art no	Barcode
100	501	4779022360800

Fire starters

Plates



Quantity	Art no	Barcode
128	504	4779022360268

Quantity	Art no	Barcode
64	503	4779022360435

Quantity	Art no	Barcode
32	502	4779022360220

Fire starters

Dry spirit, 70 pieces



Quantity	Art no	Barcode
70	506	4779022360404

Long burning matches

12 pieces



Quantity	Art no	Barcode
12	505	4779022360305

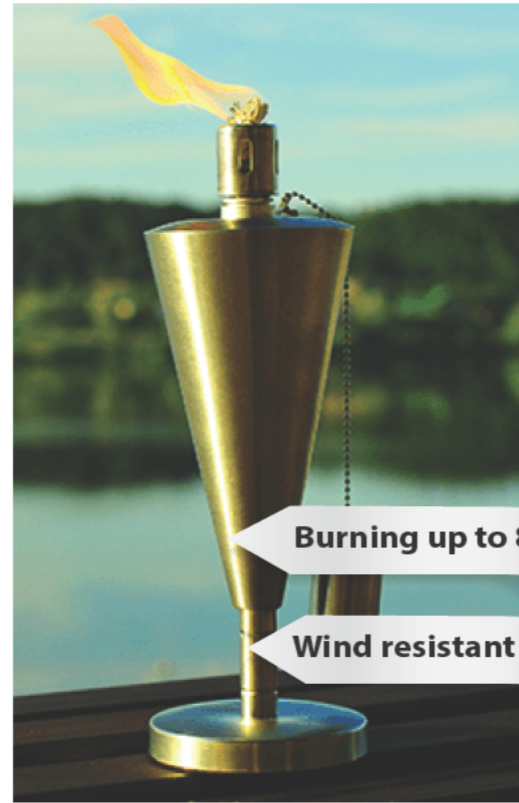

Garden torch
Made from stainless steel



Model	Art no	Barcode
H27	800	4779022361050
H115	801	4779022361067



Classic design HANSA outdoor torch will fit perfectly with the garden environment, plants and furniture. Stainless steel torch body is sturdy, durable and easy to maintain. Massive short leg ensure that the torch will stand firmly on a flat surface, and the long pointed leg makes easy to push deep into the lawn, thus ensuring that HANSA outdoor torch stand steady even stronger wind blows. Thanks to special technology, HANSA torch is wind resistant, so you can enjoy a cozy atmosphere then the wind blowing stronger. Innovative wick is not consumed and is perfectly resistant to even a couple of years. For the torch fuelling you can use flammable liquid, but for the longest combustion time, it is recommended to use fuel for torches. If you add citronella or other lemon-grass oil to fuel you will not only enjoys a refreshing scent, but also successfully repels mosquitoes, ticks and other insects!

The biochemical preparation contains active substances – enzymes. Enzymes are biological albuminous catalysts that thousands times accelerate biochemical reactions, which take place in natural organic substances. Enzymes interact with organic substances (substrates) and modify their structure. Due to such reactions, different natural organic substances are quickly dissociated. The contained surfactants facilitate equal penetration of the preparation into sewage and disperses it.

Environmentally friendly

Produced exceptionally from natural materials and organism – bacteria and enzymes. Removes organic waste and stops sewage from getting to nature.

Active bacteria!

Bacteria – living organisms, feeding on organic waste.

Bad smell vanishes

Bacteria „eat“ waste and entirely remove it. When there is no waste – no bad smell.

Even solid waste is removed

If solid waste is met, bacteria secrete special enzymes – to decompose the waste.

Waste of all kind is removed

Bacteria are capable to “identify” type of waste and to secrete proper enzymes to decompose them.

Fast process

Composition already includes enzymes – to speed up decomposition of waste.

Biochemical preparation

For outdoor toilet maintenance

Biochemical preparation

For sewerage maintenance



500 ml 810 4779022361036



500 ml 820 4779022361043



UAB "Trijų artelė" / HANSA
Topolių g. 6, LT-56336 Rumšiškės
Kaišiadorių r., Lithuania
tel./fax +370 37 750 500
info@hansaflame.com
www.hansaflame.com